

Conte[®]
ITALIAN BED DESIGN

Collection 2022

Conte[®]
ITALIAN BED DESIGN

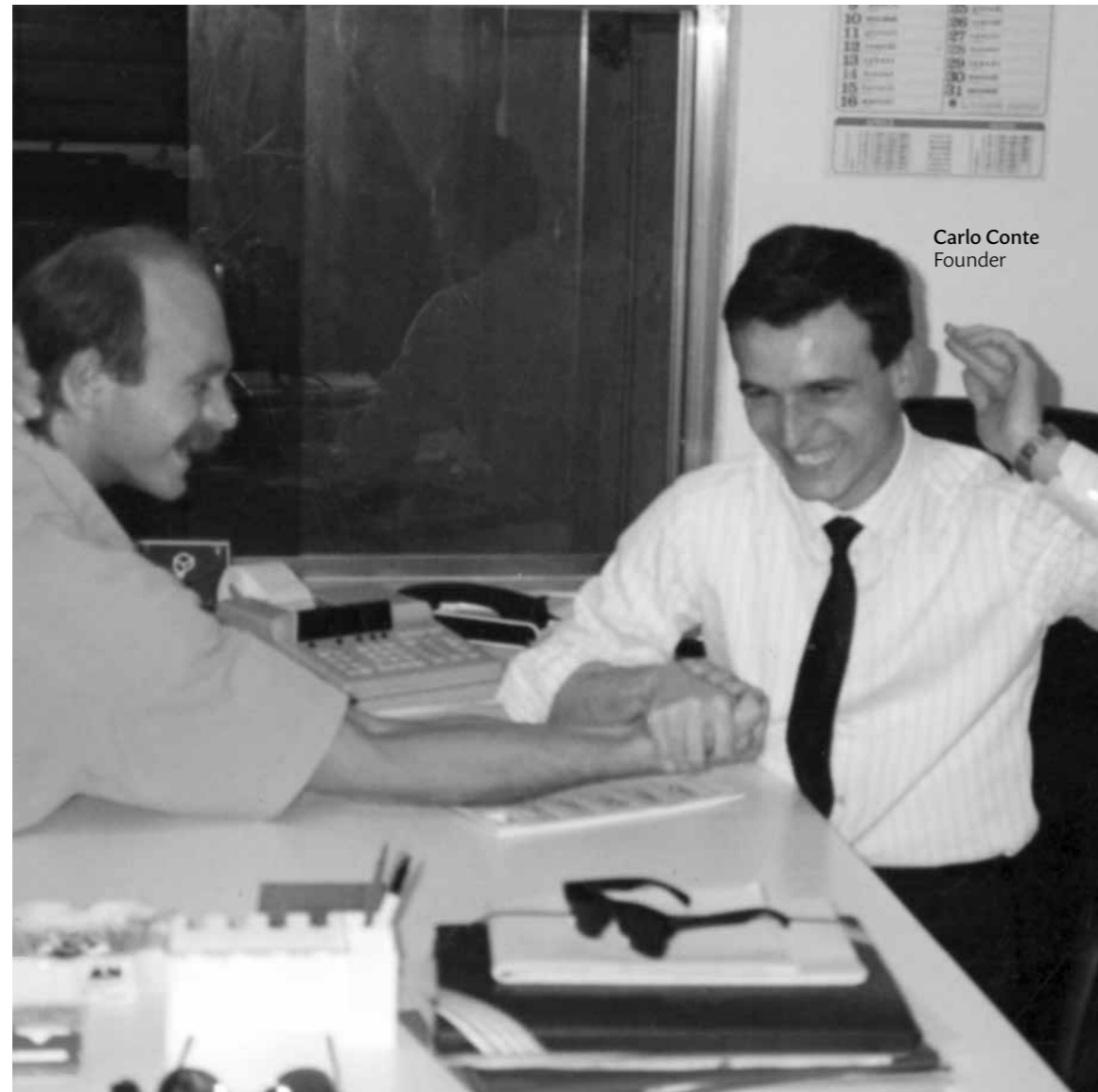

Carlo Conte
Founder

L'AZIENDA

Tutto ha inizio qui, in Puglia, sulle terre di Murgia.
Dure, impenetrabili ma capaci di grandi suggestioni.

E' il 1986 quando Carlo Conte mette tutto il suo saper fare, la sua audacia, le sue conoscenze tecniche, dentro quattro soffici angoli e li trasforma nel più grande gruppo industriale nella lavorazione di materie prime destinate al comfort e al riposo.

Comincia così il sogno imprenditoriale del gruppo Conte.

Man mano che l'azienda cresce, nasce così il brand, Conte Bed, sinonimo di comfort e qualità a livello internazionale e leader, nella produzione di materassi e letti di altissimo pregio con oltre 40.000 metri quadri di area produttiva, più di 70 dipendenti e 2 showroom di oltre 1.000 metri quadri.

Gli anni passano e accanto al signor Conte inizia a camminare suo figlio, Ferdinando. Padre e figlio, sono sinonimo di artigianalità e innovazione. Insieme, portano il Made in Italy dei loro brand a diventare garanzia di altissima qualità manifatturiera. Entrambi sono appassionati e instancabili, perché essere leader non significa solo saper guidare, significa anche e soprattutto essere in grado di incoraggiare le attitudini del singolo perché diventi parte di un progetto più grande, condiviso, sentito, poiché Conte Group prima che un'azienda è una famiglia.

THE COMPANY

*Everything started here, on the land of Murgia.
Hard, impenetrable, but capable of great charm.*

In 1986, Carlo Conte put all of his know-how, his audacity, his technical knowledge, into those corners and he transformed it into the largest industrial Group processing raw materials intended for comfort and relaxation.

And so, the entrepreneurial dream of the Conte Group began.

As the company gradually grows, the brand Conte Bed was born, synonymous with comfort and quality internationally, and a leader in the production of the highest quality mattresses and beds, with more than 40,000 meters of industrial plant, 70 employees, and 2 showrooms of over 1,000 square meters.

Years pass, and Mr. Conte's son, Ferdinando, begins to work next to his father. Father and son, synonymous with craftsmanship and innovation.

Together, they have brought their brands' Made in Italy to become a guarantee of the highest manufacturing quality. Both are passionate and tireless, because being a leader does not just mean to be able to drive, it also means, above all, being able to encourage the individual's attitudes to become part of a larger, shared, felt project, since the Conte Group before a company is a family.



Flagship store - Milan



Conte Group in the world



We are in

- | | | | | |
|-------------|----------|----------------|-----------|------------|
| Italy | France | India | Indonesia | Japan |
| Uk | Ireland | Kazakistan | Malaysia | Taiwan |
| Usa | Portugal | Russia | Sweden | Azerbaijan |
| Israel | Bulgaria | Belgium | Estonia | Qatar |
| China | Romania | Montenegro | Austria | Nigeria |
| Hong-Kong | Malta | Albania | Balkans | Lebanon |
| Singapore | Greece | Slovenia | Turkey | Panama |
| Australia | Spain | Czech Republic | Germany | Venezuela |
| Switzerland | Mexico | Emirates | Korea | Thailand |



LETTI BEDS

- 10 KENSINGTON
- 24 SOFT
- 34 TERENCE LUX
- 50 BOISERIE
- 62 SUITE
- 74 WALL
- 82 DOMINICK
- 94 HUGS
- 106 KARL
- 120 MOZART
- 132 NUAGE
- 142 CHARLIE
- 154 AVENUE
- 166 MICHELANGELO
- 178 RANIA
- 188 IVONNE ROYAL
- 202 MOSCOVA
- 212 DUPLEX

COMPLEMENTI FURNISHING

- 220 CHARLIE
- 221 NUAGE
- 222 MARIE
- 223 HUGS
- 224 AVENUE
- 225 MOSCOVA

SCRITTOI WRITING DESKS

- 226 FONTANA
- 227 IRON

PANCHE BENCHES

- 226 IRON
- 227 DOMINICK
- 228 MARIE
- 228 AVENUE
- 228 LOUIS
- 229 CORBUSIER
- 229 CHARLIE
- 229 INTRECCIO

POLTRONE ARMCHAIRS

- 230 CHARLIE
- 230 CHELSEA
- 231 HUGS
- 231 QUEEN
- 232 KARL
- 232 ANNETTE
- 233 DOMINICK

POUF POUF

- 231 QUEEN
- 233 PARIS

TAVOLINI SIDE TABLES

- 234 LOUIS
- 234 CHARLIE
- 234 IRON ALTO
- 235 BERGÈRE
- 235 VERSAILLES
- 235 IRON BASSO

CHAISE LONGUE CHAISE LONGUE

- 236 DOMINICK
- 236 MOSCOVA BASSA
- 237 MOSCOVA ALTA

SPECCHI MIRRORS

- 238 KARL
- 238 KARL MAXI
- 238 VERSAILLES
- 239 VERSAILLES MAXI
- 239 CIRCO

KENSINGTON

design Joe Garzone

Letto KENSINGTON con base in Noce Canaletto e spalla in tessuto Turandot, cat. C, col. 01, con bordini a contrasto in pelle Nabuk col. Sabbia. Comodino NUAGE MAXI due cassetti, in Noce Canaletto, con maniglie in Ottone Brunito e piano in vetro Brown. Tavolino IRON BASSO verniciato Brown, con piano in marmo Georgette. Panca MARIE in Noce Canaletto, rivestita in pelle Nabuk intrecciato colore Sabbia. Scrivitoio FONTANA in Noce Canaletto con piano in Nabuk colore Sabbia. Pouf PARIS in pelle Nabuk colore Sabbia e base in metallo Brown.

KENSINGTON bed with base in Canaletto walnut and shoulder in Turandot fabric, cat. C, colour 01, with contrasting borders in Nabuk leather, Sabbia colour. NUAGE MAXI bedside table with two drawers, in Canaletto Walnut, with handles in Bronzed Brass and top in Brown glass. Brown painted IRON BASSO side table, with Georgette marble top. MARIE bench in Canaletto Walnut, upholstered in woven Nabuk leather, Sabbia colour. FONTANA writing desk in Canaletto Walnut with Nabuk top, Sabbia colour. PARIS pouf in Nabuk leather, Sabbia colour and Brown metal base.













LETTO / BED

Il letto KENSINGTON, disegnato dall'architetto Joe Garzone, si caratterizza per la testata imbottita impreziosita dai bordini a contrasto in pelle. La base del letto dal design essenziale ed ispirato agli anni 50 è disponibile in Noce Canaletto o frassino verniciato. Il letto KENSINGTON è configurabile anche nella versione con giroletto h30 con rete contenitore.

The KENSINGTON bed, designed by architect Joe Garzone, is characterized by the padded headboard embellished with contrasting leather borders. The base of the bed, with an essential design inspired by the 1950s, is available in Canaletto Walnut or painted ash. The KENSINGTON bed can also be configured in the version with H.30 container bed frame.

COMODINO / BED SIDE TABLE

Progettato da Joe Garzone, il comodino NUAGE MAXI a due cassetti è composto da una struttura in legno massello disponibile in 5 diverse essenze, con piano in marmo, vetro o legno.

Designed by Joe Garzone, the NUAGE MAXI bedside table with two drawers is made up of a solid wood structure available in 5 different essences, with top in marble, glass or wood.

SCRITTOIO / WRITING DESK

Disegnato dall'architetto Joe Garzone e dedicato all'artista Lucio Fontana presenta forme borghesi di chiara ispirazione anni 50, la struttura è completamente in legno massello con un piano in pelle Nabuk, lo scrittoio è disponibile in 5 diverse essenze di legno.

Designed by architect Joe Garzone and dedicated to the artist Lucio Fontana, it has bourgeois forms clearly inspired by the 1950s. The structure is completely in solid wood with a top in Nabuk leather. The desk is available in 5 different types of wood.

TAVOLINO / SIDE TABLE

Il tavolino IRON BASSO presenta una struttura in metallo con piano in marmo a scelta.

The IRON BASSO side table has a metal structure and marble top in different finishes.

POUF

Il pouf PARIS è uno dei più eleganti della gamma grazie alla preziosa lavorazione capitonné, la base è disponibile in Ottone Brunito o in metallo verniciato.

The PARIS pouf is one of the most elegant in the range thanks to the precious capitonné style. The base is available in Bronzed Brass or painted metal.

KENSINGTON

Struttura

In legno multistrato, con base in legno massello in frassino verniciato o Noce Canaletto

Imbottitura

In poliuretano espanso ad alta densità

Rivestimento

In tessuto o pelle, non sfoderabile

Structure

Plywood, with solid wood base in painted ash or Canaletto walnut

Padding

In high density polyurethane foam

Upholstery

In fabric or leather, non-removable

Misure europee / European sizes

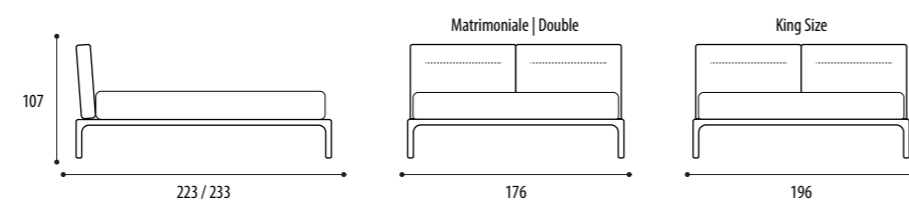

Misure americane / American Sizes

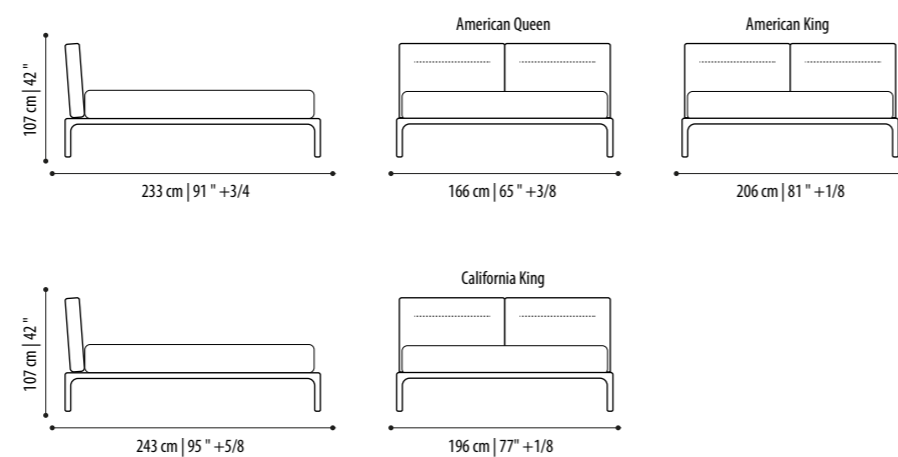

KENSINGTON H30

Struttura

In legno multistrato

Imbottitura

In poliuretano espanso ad alta densità

Rivestimento

In tessuto o pelle, parzialmente sfoderabile

Structure

In plywood

Padding

In high density polyurethane foam

Upholstery

In fabric or leather, partially removable

Misure europee / European sizes

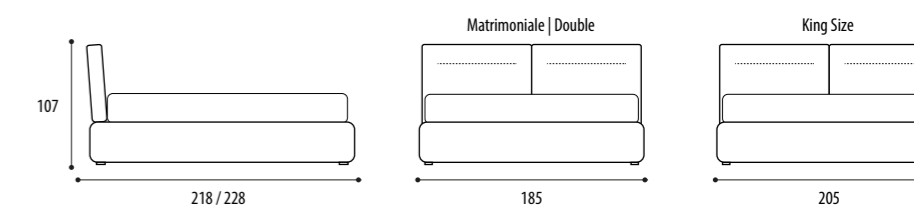

Misure americane / American Sizes

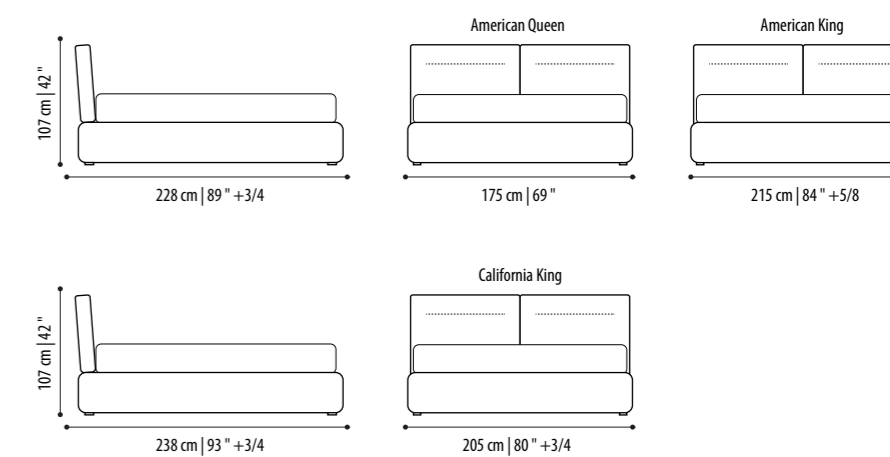

SOFT

design Joe Garzone

Letto SOFT disegnato dall'architetto Joe Garzone, in pelle Nabuk, cat. D, colore Seppia. Comodini CHARLIE ad un cassetto in Ebanò Scuro e maniglie in Ottone Brunito. Coppia di panche INTRECCIO in Nabuk col. Seppia. Specchio KARL ROYAL, versione non retroilluminata, con cornice in vetro smussato. Comò HUGS laccato lucido colore RAL 3011 con piedi in Frassino Nero con dettagli in Ottone Brunito.

SOFT bed, designed by architect Joe Garzone, in Nabuk leather, cat. D, Seppia colour. CHARLIE bedside tables with one drawer in Dark Ebony and handles in Bronzed Brass. Pair of INTRECCIO benches in Nabuk Seppia colour. KARL ROYAL mirror, non-backlit version, with beveled glass frame. HUGS chest of drawers in glossy lacquer colour RAL 3011 with feet in Black Ash with details in Bronzed Brass.









LETTO / BED

Il letto SOFT, progettato dall'architetto Joe Garzone, presenta una morbida e accogliente testata composta da un unico cuscino imbottito in soffice piuma d'oca con la possibilità di impreziosirla con cuciture a taglio vivo o con bordini a contrasto.

The SOFT bed, designed by architect Joe Garzone, has a soft and welcoming headboard consisting of a single pillow padded with soft goose down with the possibility of embellishing it with raw-cut seams or with contrasting edges.

COMODINO / BED SIDE TABLE

Il comodino CHARLIE ha linee sinuose e delicate. Composto da una struttura curvata in legno massello e disponibile nelle versioni a uno o due cassetti, i piani sono disponibili in diverse finiture di marmo, vetro o legno. le maniglie dei cassetti sono in metallo verniciato o Ottone Brunito

The CHARLIE bedside table has sinuous and delicate lines. Composed of a curved solid wood structure, it is available in versions with one or two drawers. The tops are available in different finishes in marble, glass or wood. The drawer handles are in painted metal or Bronzed Brass.

PANCA / BENCH

La panca INTRECCIO è uno dei prodotti della linea Conte che esaltano la cura del dettaglio e l'essenza del hand made, interamente intrecciata a mano è possibile configurarla in 5 tipologie di pellami in oltre 50 colorazioni

The INTRECCIO bench is one of the Conte line products that enhances the attention to detail and the essence of the handmade. Entirely hand-woven, it can be configured in 5 types of leathers in over 50 colours.

SPECCHIO / MIRROR

Lo specchio KARL ROYAL ha una struttura in vetro componibile con cornice smussata a 45 gradi. Lo specchio si rende protagonista andando ad impreziosire la parete su cui viene affisso, il modello è disponibile in 2 diverse colorazioni e nella versione retroilluminata e non.

The KARL ROYAL mirror has a modular glass structure with a 45-degree beveled frame. The mirror becomes the protagonist, embellishing the wall on which it is affixed. The model is available in 2 different colours and in the backlit and non-backlit version.

SOFT

Struttura

In legno multistrato

Imbottitura

In poliuretano espanso ad alta densità

Rivestimento

In tessuto o pelle, parzialmente sfoderabile

Structure

In plywood

Padding

In high density polyurethane foam

Upholstery

In fabric or leather, partially removable

Misure europee / European sizes

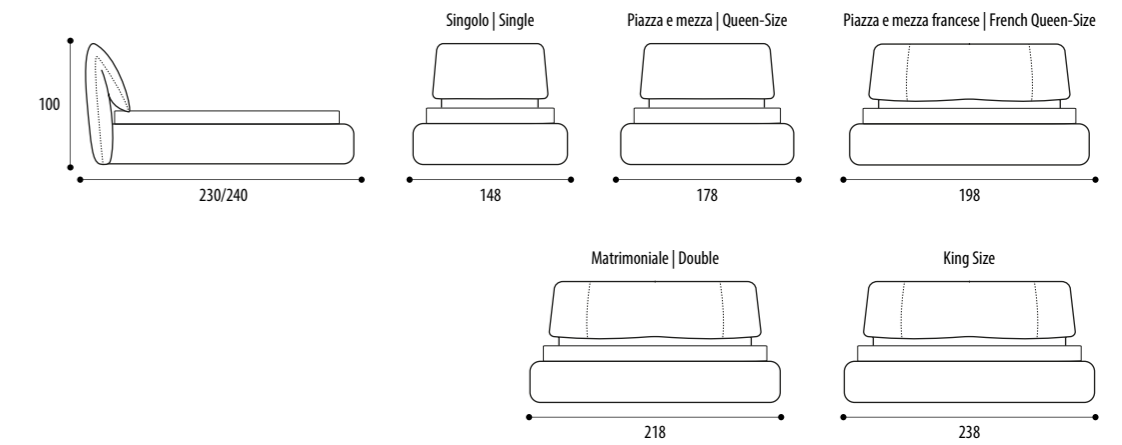

Misure americane / American Sizes

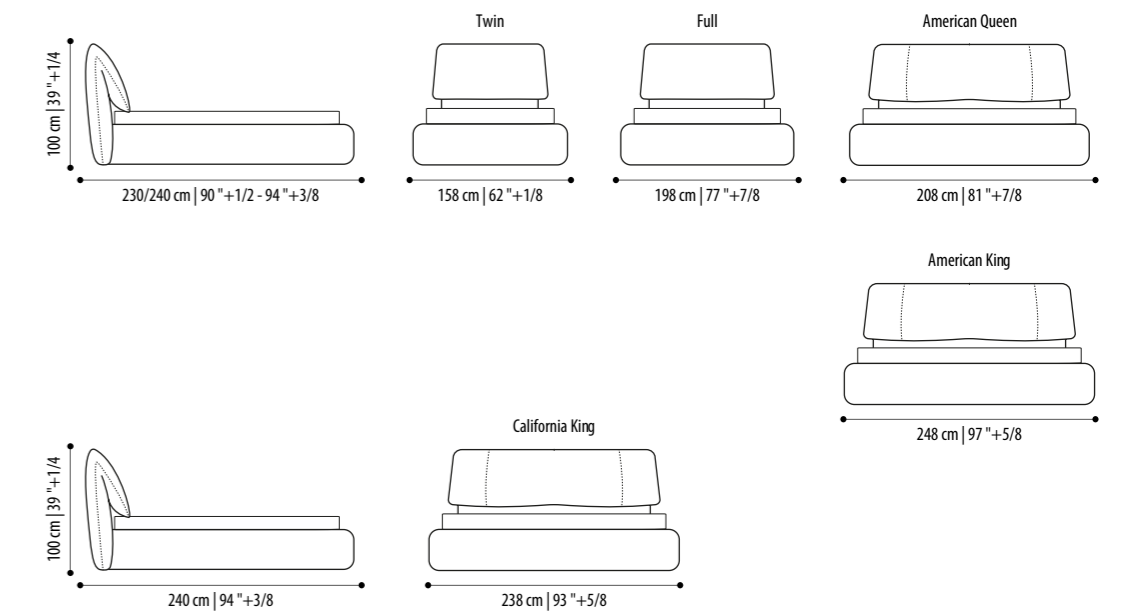

TERENCE LUX

design Conte Studio

Letto TERENCE LUX, rivestito in tessuto Turandot, cat. C, col. 01, con spalliera interna rivestita e trapuntata in pelle Nabuk col. Sabbia e base Marie laccata col. Sabbia. Coppia di comodini NUAGE MAXI a 1 cassetto in Rovere Termotrattato e piano in marmo Calacatta Oro. Tavolino BERGÈRE laccato nero con doppio piano in marmo Lepanto. Scrivitoio IRON in acciaio Antracite con specchio e dettagli in Ottone Brunito. Pouf PARIS in pelle Nabuk col. Sabbia e base in metallo Antracite.

TERENCE LUX bed, upholstered in Turandot fabric, cat. C, col. 01, with internal back upholstered and quilted in Nabuk leather, Sabbia colour and Marie base lacquered in Sabbia colour. Pair of NUAGE MAXI bedside tables with one drawer in heat-treated oak and top in Calacatta Oro marble. BERGÈRE black lacquered side table with double Lepanto marble top. IRON writing desk in Anthracite steel with mirror and details in Bronzed Brass. PARIS pouf in Nabuk leather, Sabbia colour and Anthracite metal base.















LETTO / BED

Il letto TERENCE LUX, è contraddistinto dalla particolare testata avvolgente e dalla elegante lavorazione trapuntata nell'interno spalla. Il letto è disponibile anche nella versione con spalliera interna capitonné e con giroletto H.30 con rete contenitore.

The TERENCE LUX bed is distinguished by the particular enveloping headboard and the elegant quilted workmanship on the inside shoulder. The bed is also available in the version with internal capitonné back and with H.30 container bed frame.

SCRITTOIO / WRITING DESK

Lo scrittoio IRON progettato da Joe Garzone ha linee eleganti e profili delicati. Il piano è disponibile in pelle Nabuk o eco Nabuk lavabile e smacchiabile, la struttura è in acciaio verniciata color Antracite con dettagli e specchio in Ottone Brunito.

The IRON writing desk, designed by Joe Garzone, has elegant lines and delicate profiles. The top is available in washable and stain-resistant Nabuk or eco-Nabuk leather, the structure is in anthracite painted steel with details and mirror in Bronzed Brass.

TAVOLINO / SIDE TABLE

Disegnato dall'architetto Enrico Cesana, BERGÈRE è un tavolino di grande valenza decorativa. La struttura è in legno massello stondato e laccato in abbinamento ad un doppio piano in marmo o in vetro trasparente in diverse tipologie di colorazione

Designed by architect Enrico Cesana, BERGÈRE is a side table of great decorative value. The structure is in rounded and lacquered solid wood in combination with a double top in marble or in transparent glass in different types of colours.

POUF

Il pouf PARIS è uno dei più eleganti della gamma grazie alla preziosa lavorazione capitonné, la base è disponibile in Ottone Brunito o in metallo verniciato.

The PARIS pouf is one of the most elegant in the range thanks to the precious capitonné style. The base is available in Bronzed Brass or painted metal.

TERENCE LUX

Struttura

In legno multistrato

Imbottitura

In poliuretano espanso ad alta densità

Rivestimento

In tessuto o pelle, trapuntato, parzialmente sfoderabile

Structure

In plywood

Padding

In high density polyurethane foam

Upholstery

In fabric or leather, quilted, partially removable

Misure europee / European sizes

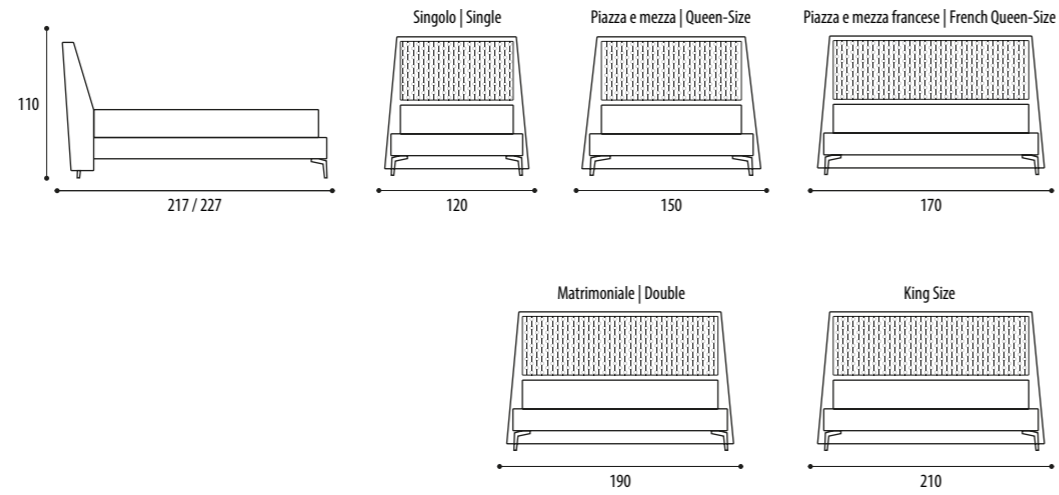

Misure americane / American Sizes

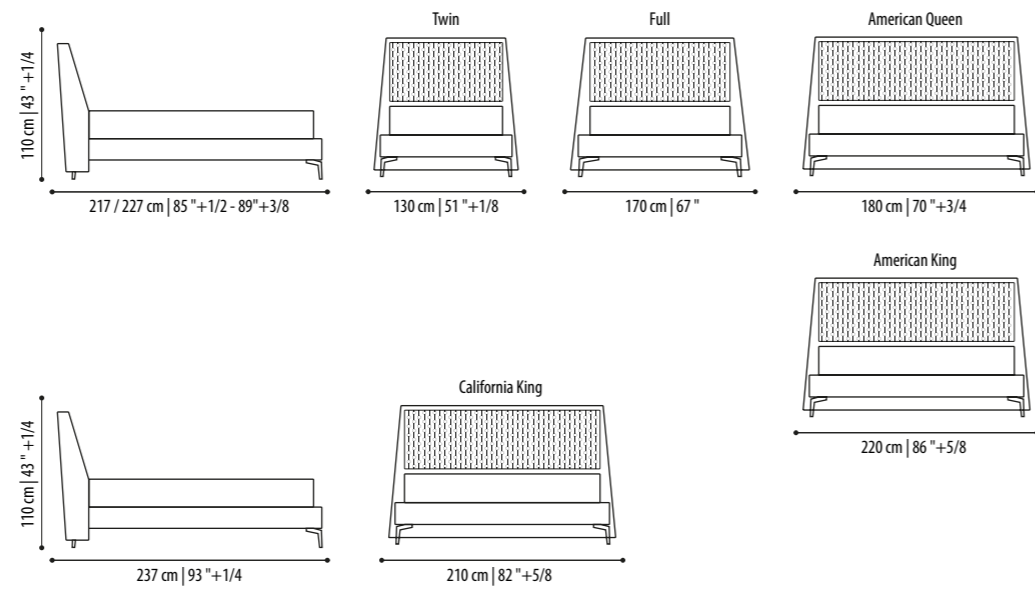

TERENCE

Struttura

In legno multistrato

Imbottitura

In poliuretano espanso ad alta densità

Rivestimento

In tessuto o pelle, parzialmente sfoderabile

Structure

In plywood

Padding

In high density polyurethane foam

Upholstery

In fabric or leather, partially removable

Misure europee / European sizes

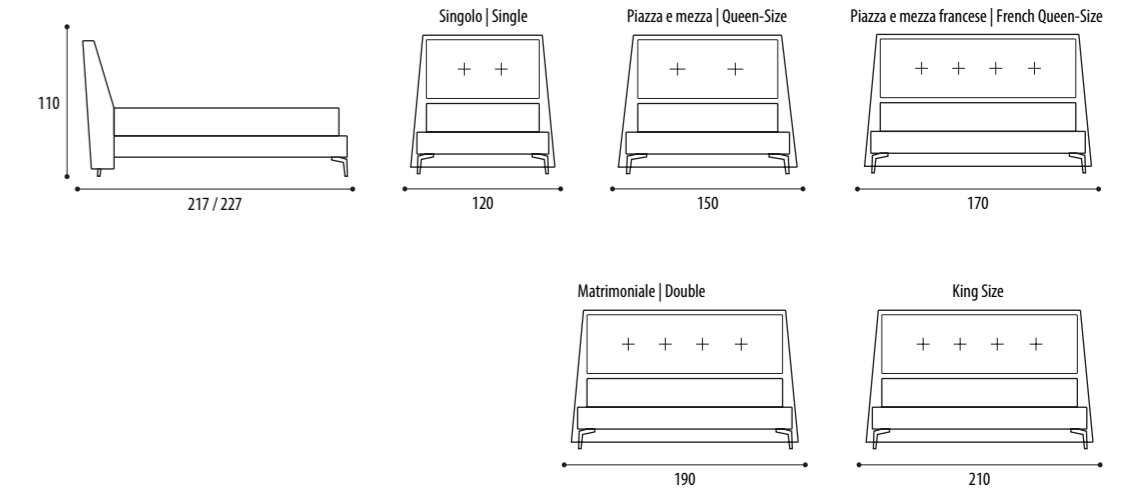

Misure americane / American Sizes

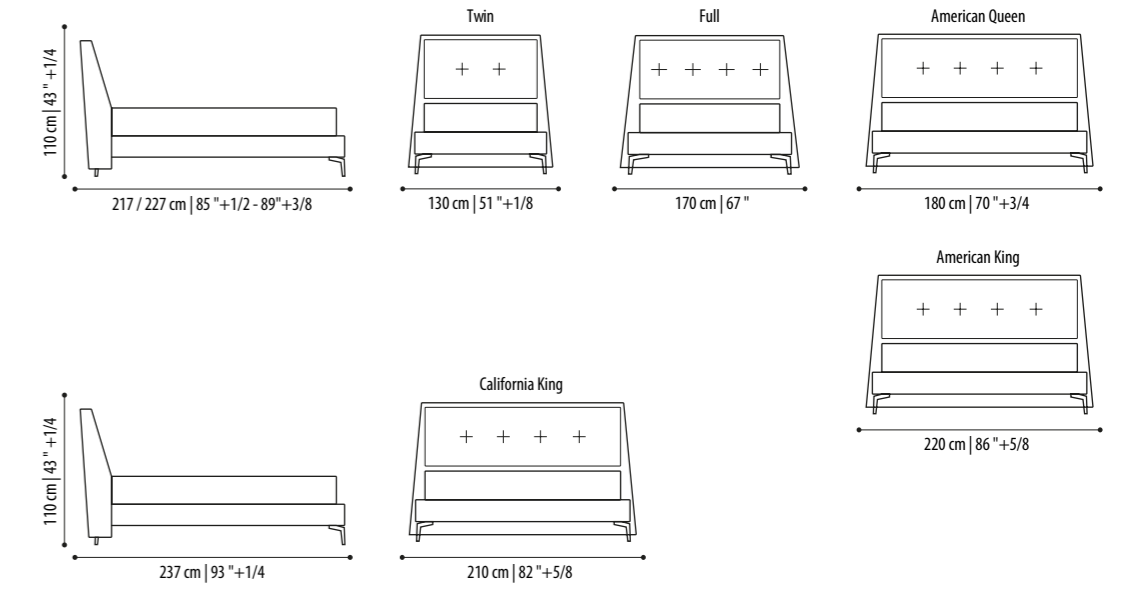

BOISERIE

design Conte Studio

Letto BOISERIE con testiera in tessuto Frida, cat. C, colore 03 e ring svasato H.30 rivestito in pelle Nabuk cat.D, colore Seppia. Coppia di comodini CHARLIE a due cassetti in Ebano Scuro, maniglie in Ottone Brunito e piano in marmo Sahara Black. Poltrona DOMINICK con struttura in Frassino Marrone e rivestimento in pelle Nabuk cat.D colore Seppia. Scrivania FONTANA in Noce Canaletto con piano in pelle Nabuk Sabbia e pouf PARIS.

BOISERIE bed with headboard in Frida fabric, cat. C, col. 03 and flared ring H.30 covered in Nabuk leather cat.D, Seppia colour. Pair of CHARLIE bedside tables with two drawers in Dark Ebony, handles in Bronzed Brass and top in Sahara Black marble. DOMINICK armchair with structure in Brown Ash and upholstery in Nabuk leather cat.D Seppia colour. FONTANA writing desk in Canaletto Walnut with Sabbia Nabuk leather top and PARIS pouf.











LETTO / BED

Il letto BOISERIE, disegnato da Joe Garzone, presenta una grande e importante testata a boiserie formata da diversi pannelli sfoderabili e componibili, configurabili in diverse dimensioni, ideale per progetti contract e residenziali. Il letto è disponibile anche con giroletto con rete contenitore.

The BOISERIE bed, designed by Joe Garzone, features a large and important boiserie headboard made up of various removable and modular panels, configurable in different sizes, ideal for contract and residential projects. The bed is also available with container bed frame.

POLTRONA / ARMCHAIR

La poltrona DOMINICK disegnata dall' architetto Enrico Cesana ha forme avvolgenti e confortevoli. La struttura è in legno massello curvato e stonato ed avvolge completamente la poltrona. Le imbottiture sono in poliuretano espanso e Memory Foam ad alta densità. Il rivestimento è disponibile in diverse varianti di tessuto o pelle.

The DOMINICK armchair, designed by architect Enrico Cesana, has enveloping and comfortable shapes. The structure is in curved and rounded solid wood and completely envelops the armchair. The padding is in polyurethane foam and high density Memory Foam.

The upholstery is available in different variants of fabric or leather.

SCRITTOIO / WRITING DESK

Disegnato dall'architetto Joe Garzone e dedicato all'artista Lucio Fontana presenta forme borghesi di chiara ispirazione anni 50, la struttura è completamente in legno massello con un piano in pelle Nabuk, lo scrittoio è disponibile i 5 diverse essenze di legno.

Designed by architect Joe Garzone and dedicated to the artist Lucio Fontana, it has bourgeois forms clearly inspired by the 1950s.

The structure is completely in solid wood with a top in Nabuk leather. The desk is available in 5 different types of wood.

COMODINO / BED SIDE TABLE

Il comodino CHARLIE ha linee sinuose e delicate. Composto da una struttura curvata in legno massello e disponibile nelle versioni a uno o due cassetti, i piani sono disponibili in diverse finiture di marmo, vetro o legno. le maniglie dei cassetti sono in metallo verniciato o Ottone Brunito.

The CHARLIE bedside table has sinuous and delicate lines. Composed of a curved solid wood structure, it is available in versions with one or two drawers. The tops are available in different finishes in marble, glass or wood. The drawer handles are in painted metal or Bronzed Brass.

POUF

Il pouf PARIS è uno dei più eleganti della gamma grazie alla preziosa lavorazione capitonné, la base è disponibile in Ottone Brunito o in metallo verniciato.

The PARIS pouf is one of the most elegant in the range thanks to the precious capitonné style. The base is available in Bronzed Brass or painted metal.

BOISERIE

Struttura

In legno multistrato

Imbottitura

In poliuretano espanso ad alta densità

Rivestimento

In tessuto o pelle, non sfoderabile

Structure

In plywood

Padding

In high density polyurethane foam

Upholstery

In fabric or leather, non-removable

Misure europee / European sizes

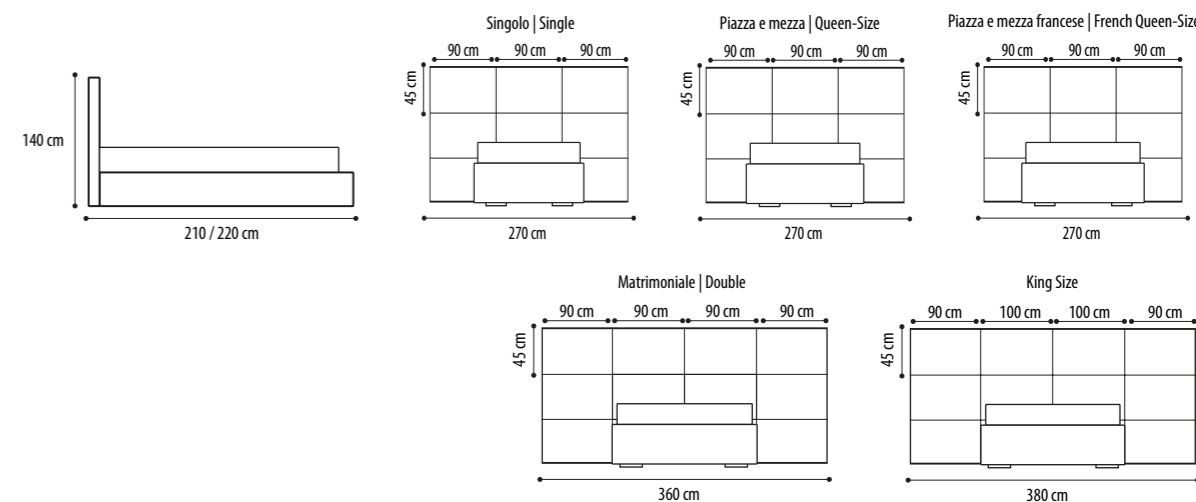

Misure americane / American Sizes

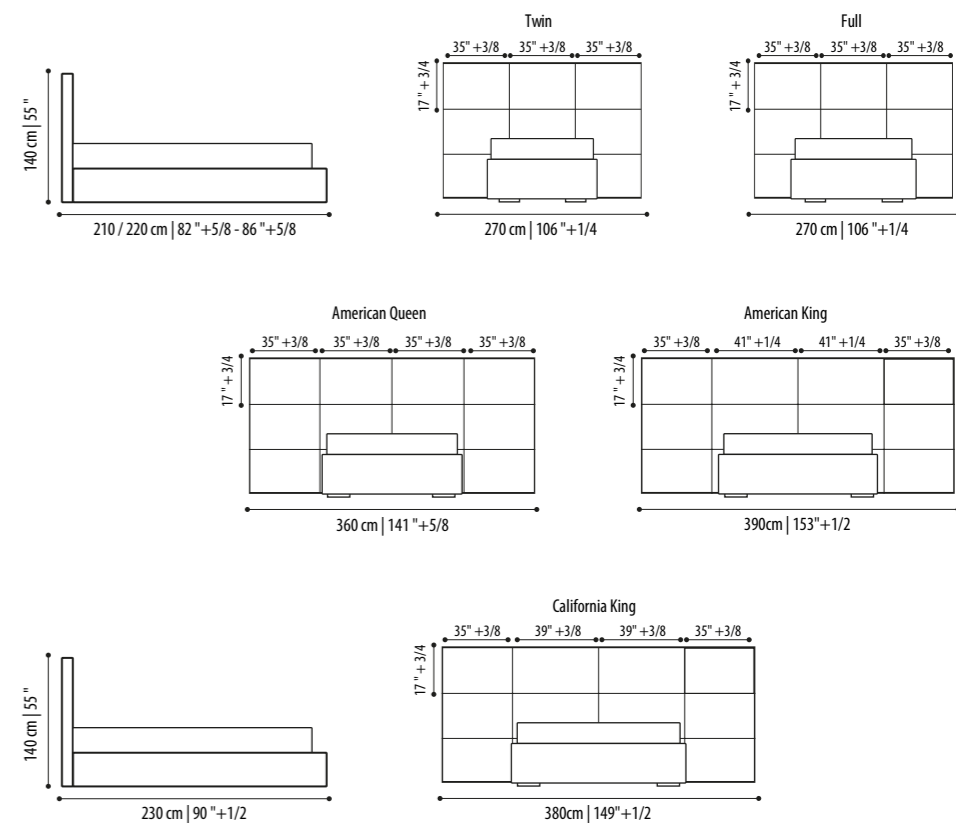

SUITE

design Giovanni Pesce

Letto SUITE, disegnato da Giovanni Pesce, struttura in metallo Brown, con tavolini in marmo Orobico Grey e coppia di lampade Suite Brown. Il letto è rivestito in pelle Nabuk, cat. D, col. Conchiglia. Panca IRON in pelle Nabuk cat. D col. Conchiglia. Comò NUAGE in Rovere Termotrattato e piano in marmo Sahara con maniglie Nickel. Specchio CIRCO verniciato colore Brown.

SUITE bed, designed by Giovanni Pesce, Brown metal structure, with Orobico Gray marble tables and a pair of Suite Brown lamps. The bed is upholstered in Nabuk leather, cat. D, Conchiglia colour. IRON bench in Nabuk leather, cat. D, Conchiglia colour. NUAGE chest of drawers in heat-treated oak and Sahara marble top with Nickel handles. CIRCO mirror painted in Brown colour.











LETTO / BED

Progettato dal designer Giovanni Pesce, il letto SUITE con le sue proporzioni importanti e la testata avvolgente diventa il protagonista della camera da letto. Nella spalliera sono incorporati tavolini in marmo in diverse finiture e lampade per un mix di eleganza e funzionalità. La struttura è in metallo verniciato Brown o Ottone Brunito ed è trapuntata e rivestita in pelle o tessuto. Il letto SUITE è disponibile nella versione con giroletto H.15 con piede e nella versione con giroletto contenitore.

Designed by designer Giovanni Pesce, the SUITE bed with its important proportions and the enveloping headboard becomes the protagonist of the bedroom. In the headboard there are incorporated marble tables in different finishes and lamps for a mix of elegance and functionality. The structure is in Brown or Bronzed Brass painted metal and is quilted and upholstered in leather or fabric. The SUITE bed is available in the version with H.15 bed frame with foot or in the version with container bed frame.

COMÒ / CHEST OF DRAWERS

Il comò NUAGE ha un design lineare e senza tempo. La struttura è disponibile in diverse finiture in abbinamento a piani in marmo, vetro o legno in diverse finiture.

The NUAGE chest of drawers has a linear and timeless design. The structure is available in different finishes in combination with marble, glass or wood tops in different finishes.

SPECCHIO / MIRROR

La struttura geometrica dello specchio CIRCO arreda con eleganza ogni ambiente ed è disponibile nelle finiture Brown o Ottone Brunito.

The geometric structure of the CIRCO mirror elegantly furnishes any environment and is available in Brown or Bronzed Brass finishes.

PANCA / BENCH

La panca IRON ha una struttura in metallo Antracite con dettagli in Ottone Brunito, che supporta un morbido cuscino rivestito in pelle o tessuto.

The IRON bench has an Anthracite metal structure with details in Bronzed Brass, which supports a soft pillow upholstered in leather or fabric.

SUITE

Struttura

In metallo verniciato Brown o colore ottone Brunito

Imbottitura

In poliuretano espanso ad alta densità

Rivestimento

In tessuto o pelle, parzialmente sfoderabile

Accessori

Tavolini in marmo in diverse finiture e lampade in metallo verniciato Brown o colore ottone Brunito

Structure

In Brown painted metal or bronzed brass colour

Padding

In high density polyurethane foam

Upholstery

In fabric or leather, partially removable

Accessories

Marble side tables in different finishes and lamps in Brown painted metal or bronzed brass colour

Misure europee / European sizes

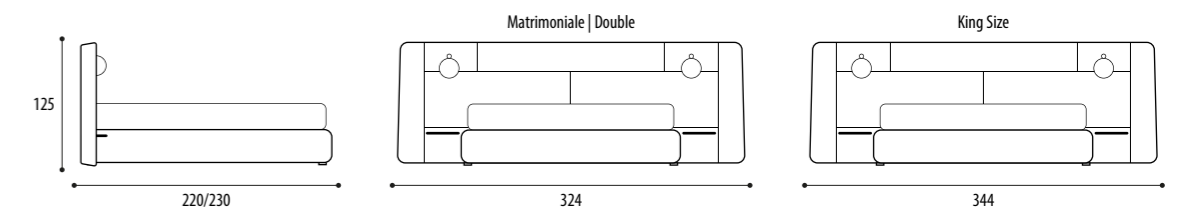

Misure americane / American Sizes

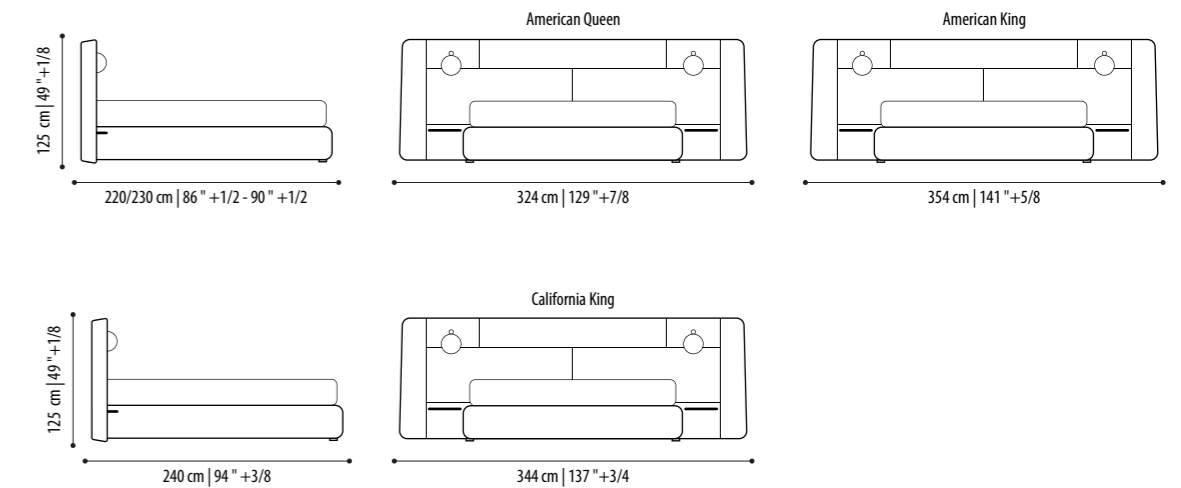

WALL

design Joe Garzone

Letto WALL, disegnato da Joe Garzone, rivestito in velluto Vogue sfoderabile, Cat. A, colore 23, con giroletto H.15 in abbinamento alla base Marie in Frassino Nero. Panca IRON in velluto Vogue, Cat. A, colore 23, con struttura in metallo Antracite e dettagli in Ottone Brunito. Coppia di comodini CHARLIE ad un cassetto, in Ebano Scuro e maniglie in Ottone Brunito. Scrivania IRON con piano in pelle Nabuk colore Sabbia e struttura in metallo Antracite con dettagli e specchio in Ottone Brunito. Pouf PARIS in pelle Nabuk colore Sabbia e base in metallo Antracite.

WALL bed, designed by Joe Garzone, upholstered in removable Vogue velvet, Cat. A, col. 23, with H.15 bed frame in combination with the Marie base in Black Ash. IRON bench in Vogue velvet, Cat. A, col. 23, with structure in Anthracite metal and details in Bronzed Brass. Pair of CHARLIE bedside tables with one drawer, in Dark Ebony and handles in Bronzed Brass. IRON writing desk with top in Nabuk leather, Sabbia colour and Anthracite metal structure with details and mirror in Bronzed Brass. PARIS pouf in Sabbia colour Nabuk leather and Anthracite metal base.







LETTO / BED

Il letto WALL, disegnato da Joe Garzone, presenta una grande e importante testata a boiserie formata da diversi pannelli sfoderabili e componibili, configurabili in diverse dimensioni, ideale per progetti contract e residenziali.

Il letto è disponibile anche con giroletto con rete contenitore.

The WALL bed, designed by Joe Garzone, features a large and important boiserie headboard made up of various removable and modular panels, configurable in different sizes, ideal for contract and residential projects. The bed is also available in the version with container bed frame.

COMODINO / BED SIDE TABLE

Il comodino CHARLIE ha linee sinuose e delicate. Composto da una struttura curvata in legno massello e disponibile nelle versioni a uno o due cassetti, i piani sono disponibili in diverse finiture di marmo, vetro o legno. Le maniglie dei cassetti sono in metallo verniciato o Ottone Brunito.

The CHARLIE bedside table has sinuous and delicate lines. Composed of a curved solid wood structure, it is available in versions with one or two drawers. The tops are available in different finishes in marble, glass or wood. The drawer handles are in painted metal or Bronzed Brass.

SCRITTOIO / WRITING DESK

Lo scrittoio IRON progettato da Joe Garzone ha linee eleganti e profili delicati. Il piano è disponibile in pelle Nabuk o Eco Nabuk lavabile e smacchiabile, la struttura è in acciaio verniciata color Antracite con dettagli e specchio in Ottone Brunito.

The IRON writing desk, designed by Joe Garzone, has elegant lines and delicate profiles. The top is available in washable and stain-resistant Nabuk or eco-Nabuk leather, the structure is in anthracite painted steel with details and mirror in Bronzed Brass.

PANCA / BENCH

La panca IRON ha una struttura in metallo Antracite con dettagli in Ottone Brunito, che supporta un morbido cuscino rivestito in pelle o tessuto.

The IRON bench has an Anthracite metal structure with details in Bronzed Brass, which supports a soft pillow upholstered in leather or fabric.

POUF

Il pouf PARIS è uno dei più eleganti della gamma grazie alla preziosa lavorazione capitonné, la base è disponibile in Ottone Brunito o in metallo verniciato.

The PARIS pouf is one of the most elegant in the range thanks to the precious capitonné style. The base is available in Bronzed Brass or painted metal.

WALL

Struttura

Legno multistrato

Imbottitura

In poliuretano espanso ad alta densità

Rivestimento

In tessuto o pelle, non sfoderabile

Structure

In plywood

Padding

In high density polyurethane foam

Upholstery

In fabric or leather, non-removable

Misure europee / European sizes

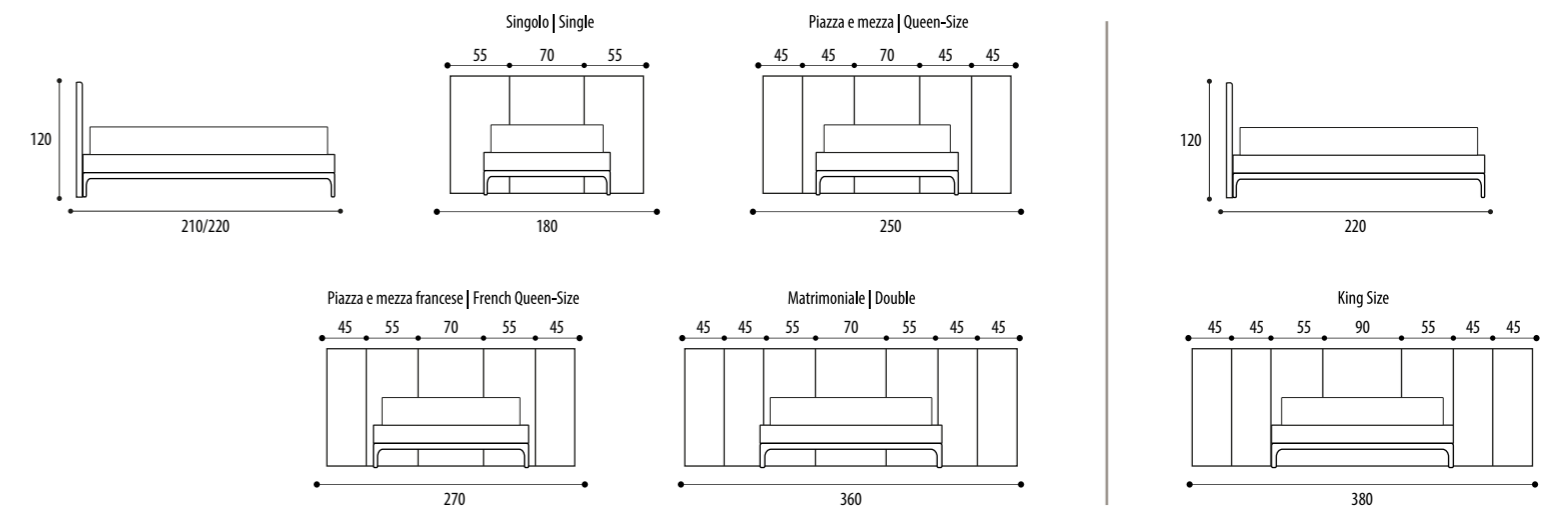

Misure americane / American Sizes

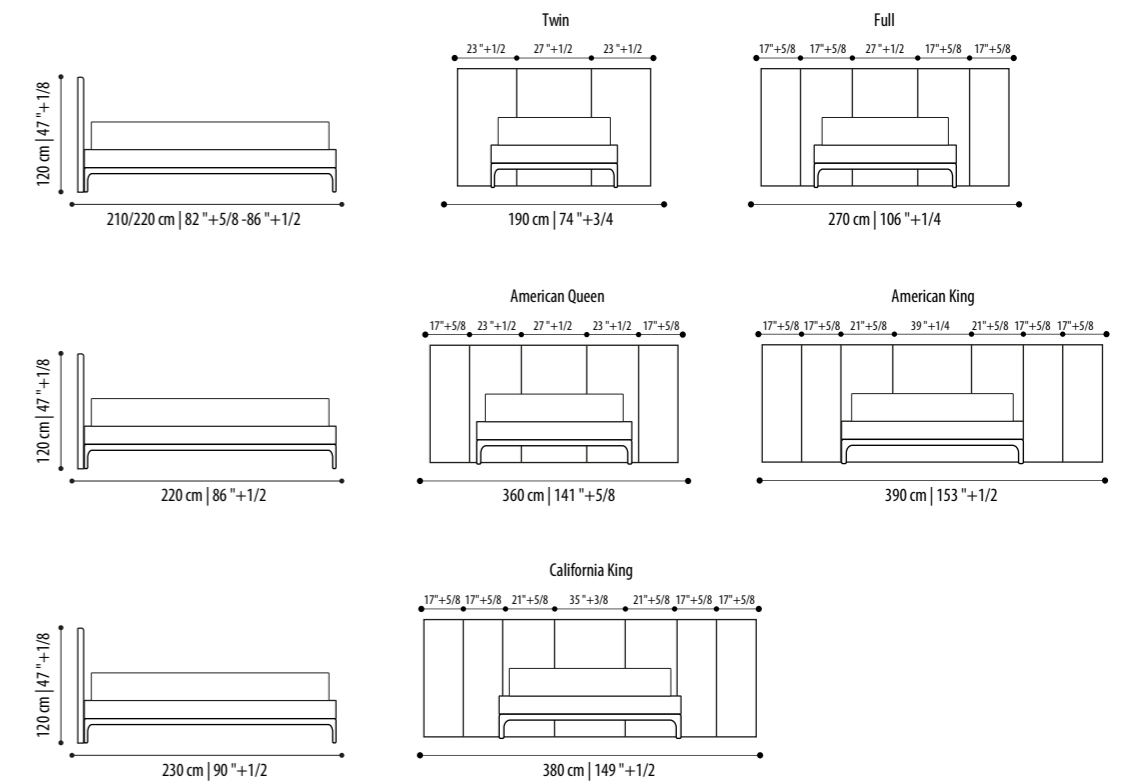

DOMINICK

design Enrico Cesana

Letto DOMINICK, disegnato dall'architetto Enrico Cesana, in tessuto M039, Cat. B, col. 21 e struttura in Frassino Marrone. Comodino NUAGE in Rovere Termotrattato con 2 cassetti e piano in marmo Calacatta Oro. Coppia di comodini NUAGE MAXI un cassetto, in Rovere Termotrattato con piano in marmo Calacatta Oro e maniglie in Ottone Brunito. Panca DOMINICK, con struttura in Frassino Marrone e tessuto M039, Cat. B, col. 21. Coppia di specchi VERSAILLES con struttura in metallo Brown.

DOMINICK bed, designed by architect Enrico Cesana, in fabric M039, Cat. B, col. 21 and structure in Brown Ash. NUAGE bedside table in heat-treated oak with two drawers and Calacatta Oro marble top. Pair of NUAGE MAXI bedside tables with one drawer, in heat-treated oak with Calacatta Oro marble top and Bronzed Brass handles. DOMINICK bench, with structure in Brown Ash and fabric M039, Cat. B, col. 21. Pair of VERSAILLES mirrors with Brown metal structure.





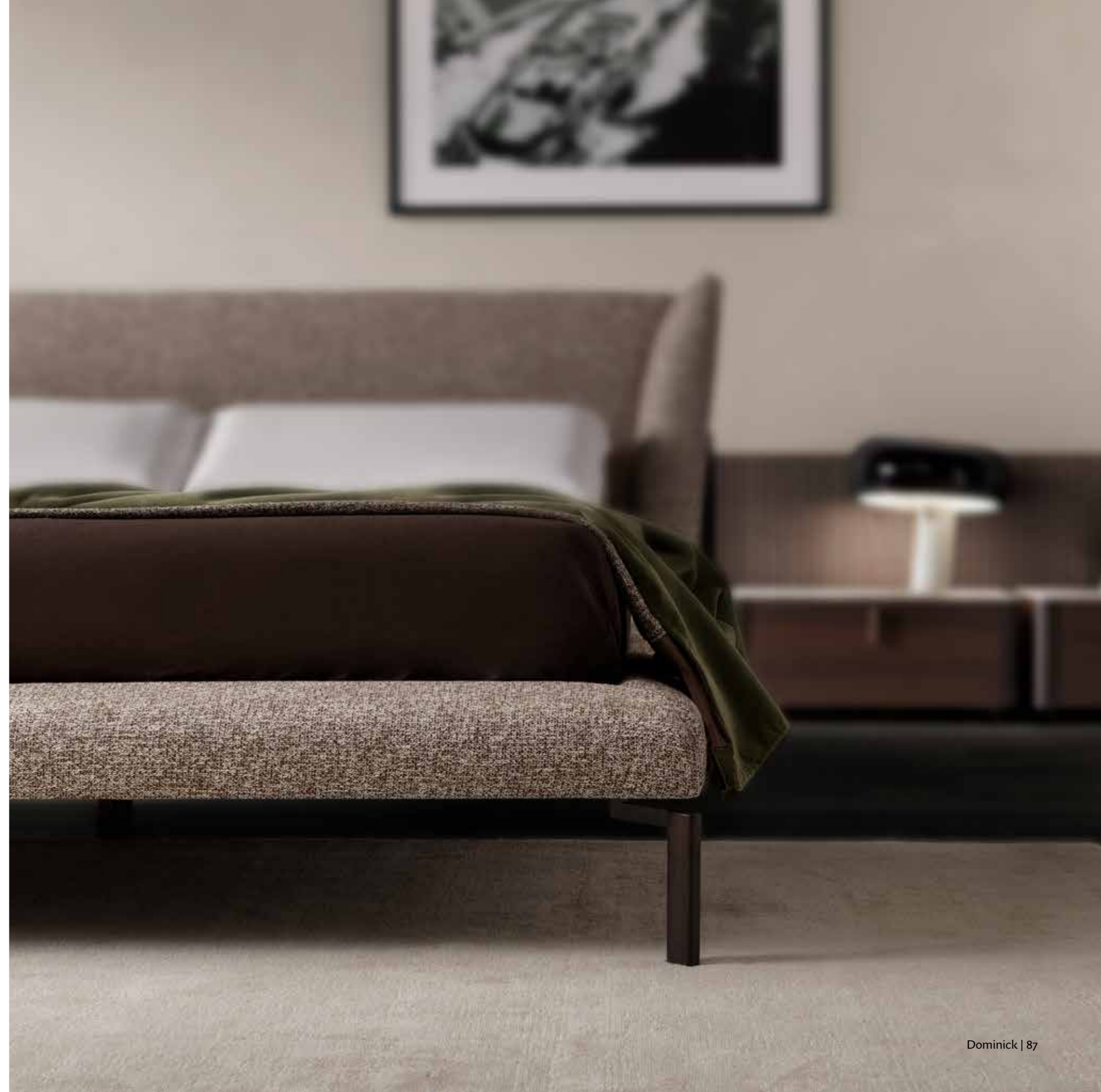





LETTO / BED

Il letto DOMINICK, progettato dall'architetto Enrico Cesana, ha tutto il fascino di un design lineare con un carattere morbido e accogliente. Il letto presenta una struttura in legno massello curvato che avvolge tutta la spalliera imbottita e un giroletto di design con un piano di riposo in legno massello microforato per garantire la massima traspirazione.

Il letto DOMINICK è disponibile anche nella versione con ring H.30 con rete contenitore a uno o due movimenti.

The DOMINICK bed, designed by architect Enrico Cesana, has all the charm of a linear design with a soft and welcoming character.

The bed has a curved solid wood structure that wraps around the padded backrest and a design bed frame with a micro-perforated solid wood resting surface, to ensure maximum breathability. The DOMINICK bed is also available in the version with ring H.30 with one or two movements container bed frame.

COMODINO / BED SIDE TABLE

Il comodino NUAGE presenta linee pulite e semplici, con due cassetti in legno massello, il piano è in pregiato marmo Calacatta Oro con maniglie in Ottone Brunito. Il modello è disponibile in diverse finiture di legno, marmo e vetro.

Il comodino NUAGE MAXI presenta una struttura in legno massello composta da un unico cassetto con piano in marmo in diverse finiture a scelta. Le maniglie sono disponibili Ottone Brunito o metallo verniciato

The NUAGE bedside table has clean and simple lines, with two solid wood drawers, the top in precious Calacatta Oro marble and handles in Bronzed Brass. The model is available in different finishes of wood, marble and glass.

The NUAGE MAXI bedside table has a solid wood structure consisting of a single drawer, with a marble top in different finishes of your choice. The handles are available in Bronzed Brass or painted metal.

PANCA / BENCH

La panca DOMINICK disegnata dall'architetto Enrico Cesana è composta da un elegante struttura in legno massello curvato che avvolge il morbido cuscino rivestito in tessuto o pelle.

The DOMINICK bench, designed by architect Enrico Cesana, is made up of an elegant curved solid wood structure, which wraps around the soft pillow upholstered in fabric or leather.

SPECCHIO / MIRROR

Lo specchio VERSAILLES presenta un'estetica essenziale e semplice ed è circondato da una cornice in metallo verniciato o in Ottone Brunito. Lo specchio VERSAILLES è disponibile in due diverse misure.

The VERSAILLES mirror has an essential and simple aesthetic and is surrounded by a painted metal or Bronzed Brass frame. The VERSAILLES mirror is available in two different sizes.

DOMINICK

Struttura

Massello in frassino verniciato o Noce Canaletto

Imbottitura

In poliuretano espanso ad alta densità

Rivestimento

In tessuto o pelle, parzialmente sfoderabile

Structure

Solid wood in varnished ash or Canaletto walnut with details in brass or varnished metal

Padding

In high density polyurethane foam

Upholstery

In fabric or leather, partially removable

Misure europee / European sizes



Misure americane / American Sizes

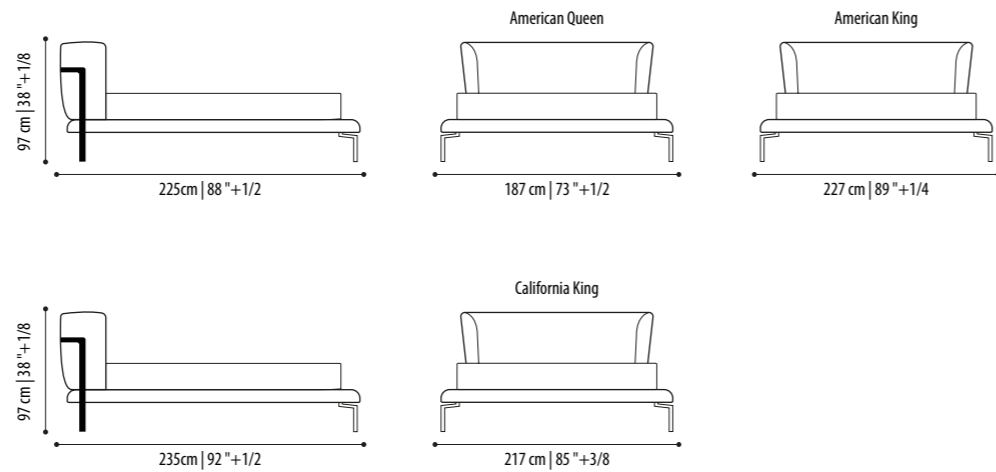

DOMINICK h30

Struttura

Massello in frassino verniciato o Noce Canaletto

Imbottitura

In poliuretano espanso ad alta densità

Rivestimento

In tessuto o pelle, parzialmente sfoderabile

Structure

Solid wood in varnished ash or Canaletto walnut with details in brass or varnished metal

Padding

In high density polyurethane foam

Upholstery

In fabric or leather, partially removable

Misure europee / European sizes

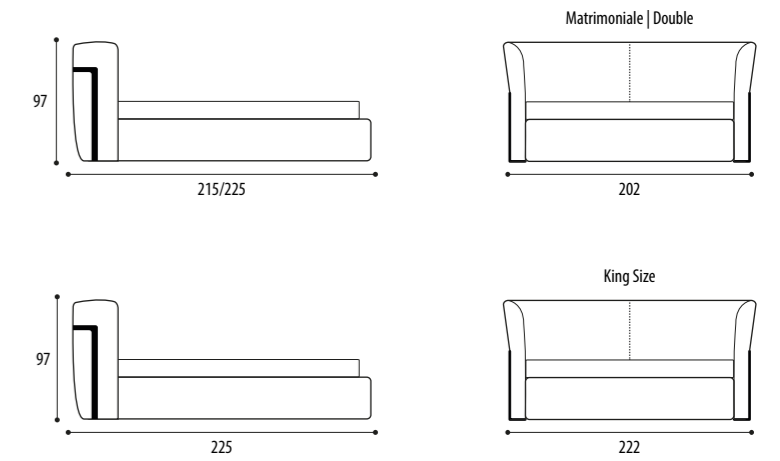

Misure americane / American Sizes

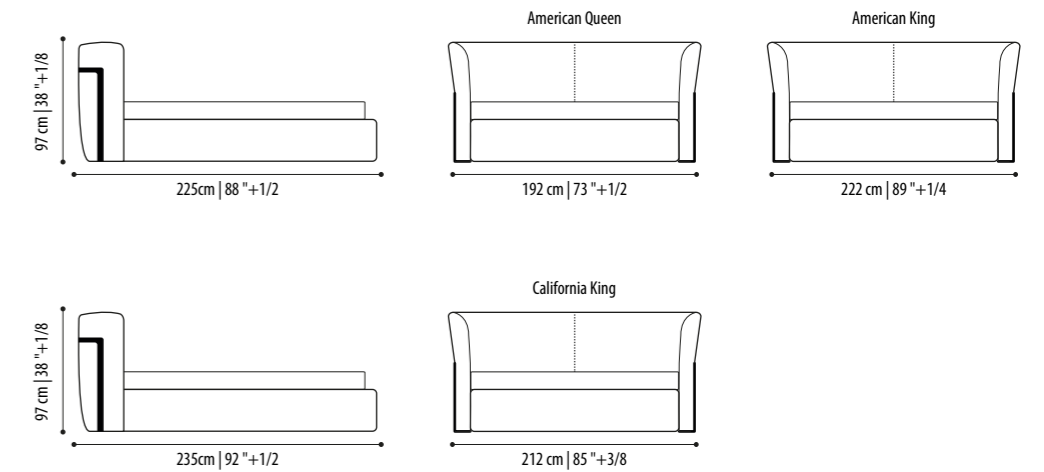

HUGS

design Joe Garzone

Letto HUGS, progettato da Joe Garzone, con struttura in Frassino Grigio e dettagli in Ottone Brunito, la spalliera è trapuntata e rivestita in pelle Nabuk cat. D, col. Sabbia. Comodino CHARLIE due cassetti in Rovere Sabbia con maniglie Brown e piano in vetro Fumé. Tavolino IRON BASSO verniciato Brown con piano in marmo Georgette. Poltrona CHARLIE bicolore, rivestita in pelle Nabuk color Oceano e tessuto, cat. C, col. Trieste 03. Poltroncina Annette in tessuto M039, Cat. B, col. 21 e piedi in Frassino Marrone.

HUGS bed, designed by Joe Garzone, with structure in Gray Ash and details in Bronzed Brass, the backrest is quilted and upholstered in Nabuk leather, cat. D, Sabbia colour. CHARLIE bedside table with two drawers in Rovere Sabbia with Brown handles and Fumé glass top. IRON BASSO Brown painted side table with Georgette marble top. CHARLIE two-tone armchair, upholstered in Nabuk leather, Oceano colour and fabric, cat. C, col. Trieste 03. Annette armchair in fabric M039, Cat. B, col. 21 and feet in Brown Ash.











LETTO / BED

Il letto HUGS, disegnato dall'architetto Joe Garzone, con linee eleganti ed essenziali, presenta una struttura in legno massello stondata e dettagli in Ottone Brunito.

Il rivestimento trapuntato è disponibile in diverse alternative di tessuto o pelle.

The HUGS bed, designed by architect Joe Garzone, with elegant and essential lines, has a rounded solid wood structure and details in Bronzed Brass. The quilted upholstery is available in different alternatives of fabric or leather.

COMODINO / BED SIDE TABLE

Il comodino CHARLIE ha linee sinuose e delicate. Composto da una struttura curvata in legno massello e disponibile nelle versioni a uno o due cassetti, i piani sono disponibili in diverse finiture di marmo, vetro o legno. le maniglie dei cassetti sono in metallo verniciato o Ottone Brunito

The CHARLIE bedside table has sinuous and delicate lines. Composed of a curved solid wood structure, it is available in versions with one or two drawers. The tops are available in different finishes in marble, glass or wood. The drawer handles are in painted metal or Bronzed Brass.

TAVOLINO / SIDE TABLE

Il tavolino IRON BASSO presenta una struttura in metallo e piano in marmo in diverse finiture.

The IRON BASSO side table has a metal structure and marble top in different finishes.

POLTRONA / ARMCHAIR

Sinuosa e avvolgente, la poltrona CHARLIE è rivestita in pelle o tessuto con una base in metallo o Ottone Brunito.

La poltroncina ANNETTE presenta una struttura schiumata in poliuretano non sfoderabile rivestita in pelle o tessuto e piedi in legno massello disponibili in più di 5 colori.

Sinuous and enveloping, the CHARLIE armchair is upholstered in leather or fabric with a metal or Bronzed Brass base.

The ANNETTE armchair has a non-removable polyurethane foam structure, upholstered in leather or fabric and solid wood feet available in more than 5 colours.

HUGS

Struttura

Massello in grassino verniciato o Noce Canaletto con dettagli in ottone o metallo verniciato

Imbottitura

In poliuretano espanso ad alta densità

Rivestimento

In tessuto o pelle, trapuntato, non sfoderabile

Structure

Solid wood in varnished ash or Canaletto walnut with details in brass or varnished metal

Padding

In high density polyurethane foam

Upholstery

In fabric or leather, quilted, partially removable

Misure europee / European sizes

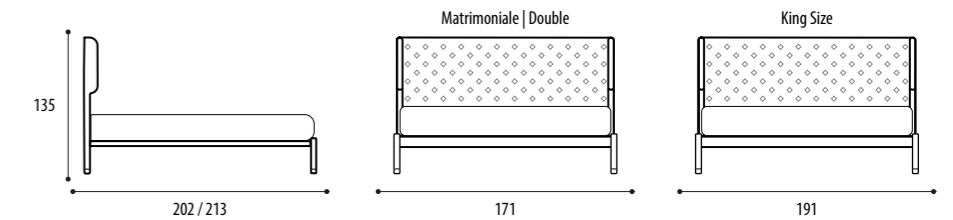

Misure americane / American Sizes

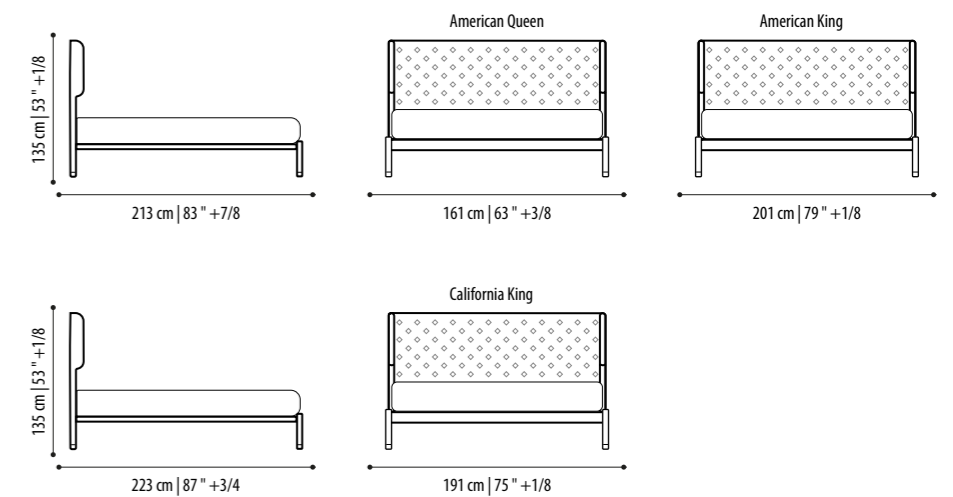

KARL

design Joe Garzone

Letto KARL, con spalliera posteriore in pelle Nabuk col. Conchiglia, giroletto e cuscini intrecciati in pelle Nabuk col. Seppia e piedini Eiffel Brown. Comodino MOSCOVA in Ebanò Scuro con cassetto laccato Seppia e piano in pelle Nabuk colore Seppia. Tavolino VERSAILLES Black con piano in marmo Sahara. Poltrona KARL in velluto Vegas, Cat. C, colore 76.

KARL bed, with backrest in Nabuk leather, Conchiglia colour, bed frame and intertwined pillows in Nabuk leather, Seppia colour and Eiffel Brown feet. MOSCOVA bedside table in Dark Ebony with Seppia lacquered drawer and top in Nabuk leather, Seppia colour. VERSAILLES Black side table with Sahara marble top. KARL armchair in Vegas velvet, Cat. C, col. 76.













LETTO / BED

Il letto KARL, disegnato dall'architetto Joe Garzone, è un letto che si rende protagonista in qualsiasi ambiente, la sofisticata lavorazione ad intreccio applicata sui cuscini anteriori della spalla è la massima espressione del hand made. Il giroletto, è disponibile sia in versione alta con piedi in metallo verniciato che con base in legno massello che in versione con giroletto contenitore. I cuscini intrecciati sono disponibili solo nella versione in pelle in opzione abbinabili anche alle versioni in tessuto del modello, il cuscino anteriore nella versione standard in tessuto è liscio. Il letto è disponibile anche nella versione con struttura baldacchino in legno massello verniciato in diverse colorazioni.

The KARL bed, designed by architect Joe Garzone, is a bed that becomes the protagonist in any environment. The sophisticated weaving applied to the front shoulder pillows is the maximum expression of Italian handmade. The bed frame is available in the high version with painted metal feet or with solid wood base or in the version with container bed frame.

The bed with leather upholstery is combined with two woven leather pillows. In the fabric version the pillows are in smooth fabric or, as an option, in woven leather. The bed is also available in the version with canopy structure in solid wood painted in different colours.

POLTRONA / ARMCHAIR

La poltrona KARL si caratterizza per le linee armoniche e avvolgenti con una struttura schiumata in poliuretano ad alta densità con più di 500 varianti di rivestimento in tessuto o pelle. I piedi sono in legno massello verniciato Brown o Black.

The KARL armchair is characterized by harmonious and enveloping lines with a high-density polyurethane foam structure with more than 500 variants of fabric or leather upholstery. The feet are in Brown or Black varnished solid wood.

COMODINO / BED SIDE TABLE

Elegante nelle linee e prezioso nei materiali, il comodino MOSCOVA presenta una struttura in legno massello impiallacciato con cassetto interno laccato opaco in abbinamento colore al piano. Il piano è disponibile in Nabuk o eco Nabuk lavabile e smacchiabile.

Elegant in its lines and precious in its materials, the MOSCOVA bedside table has a solid wood veneer structure with an internal drawer in matt lacquer matching the colour of the top. The top is available in washable and stain-resistant Nabuk or eco-Nabuk.

TAVOLINO / SIDE TABLE

Il tavolino VERSAILLES presenta un'estetica essenziale con una struttura in metallo verniciato con piano in marmo o vetro in diverse finiture.

The VERSAILLES side table has an essential aesthetic with a painted metal structure with marble or glass top in different finishes.

COMÒ / CHEST OF DRAWERS

Elegante nelle linee e prezioso nei materiali, il comò MOSCOVA presenta una struttura in legno massello impiallacciato con cassetto interno laccato opaco in abbinamento colore al piano. Il piano è disponibile in Nabuk o eco Nabuk lavabile e smacchiabile.

Elegant in its lines and precious in its materials, the MOSCOVA chest of drawers has a solid wood veneer structure with an internal drawer in matt lacquer matching the colour of the top. The top is available in washable and stain-resistant Nabuk or eco-Nabuk.

KARL

Struttura Letto

In legno multistrato

Imbottitura

In poliuretano espanso ad alta densità

Rivestimento

In tessuto o pelle, parzialmente sfoderabile e cuscino interno, in pelle o tessuto, disponibile in versione liscia o intrecciata

Structure

In plywood

Padding

In high density polyurethane foam

Upholstery

In fabric or leather, partially removable and inner pillow, in leather or fabric, available in smooth or woven version

Misure europee / European sizes

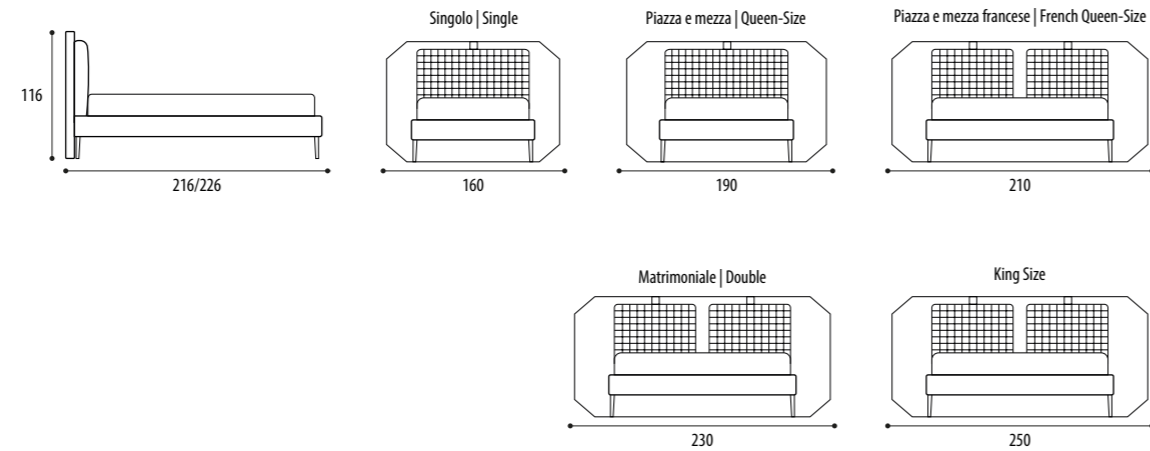

Misure americane / American Sizes

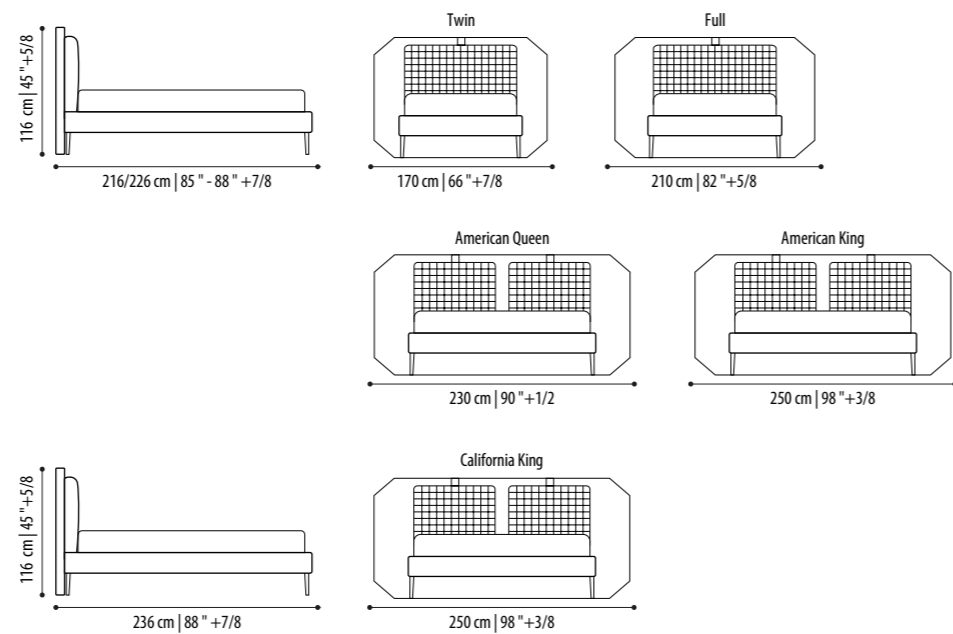

KARL BALDACCHINO

Struttura Baldacchino

Massello in frassino verniciato in diverse finiture

Struttura Letto

In legno multistrato

Imbottitura

In poliuretano espanso ad alta densità

Rivestimento

In tessuto o pelle, parzialmente sfoderabile e cuscino interno, in pelle o tessuto, disponibile in versione liscia o intrecciata

Canopy Structure

Solid ash wood painted in different finishes

Structure

In plywood

Padding

In high density polyurethane foam

Upholstery

In fabric or leather, partially removable and inner pillow, in leather or fabric, available in smooth or woven version

Misure europee / European sizes

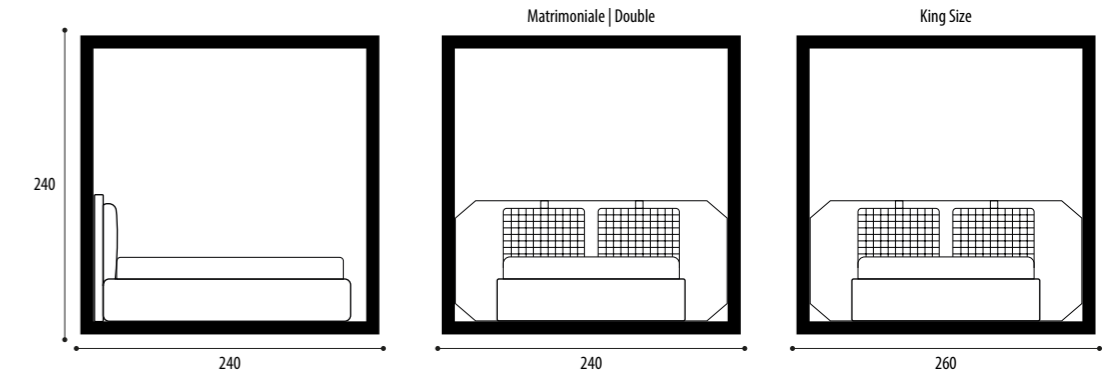

Misure americane / American Sizes

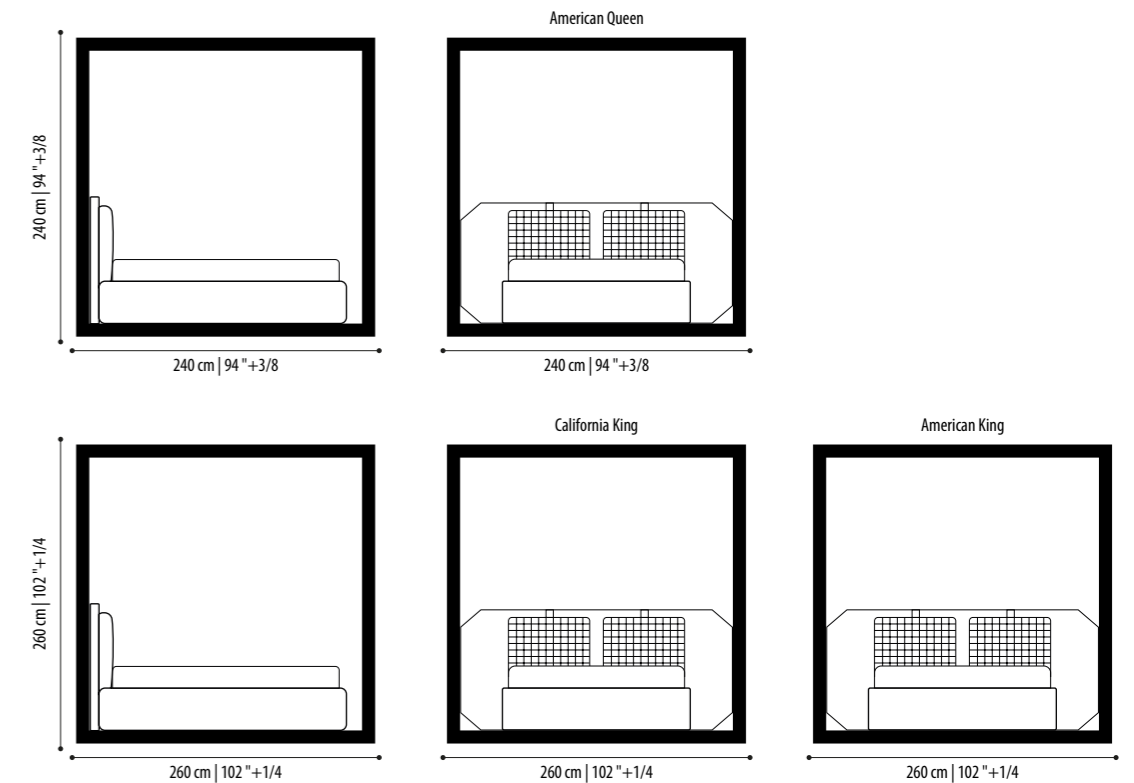

MOZART

design Conte Studio

Letto MOZART rivestito in tessuto M150, Cat. C, colore 26, con giroletto h15 con base Marie in Frassino Marrone. Comodino e comò MARIE in Rovere Termotrattato e piano in marmo Calacatta Oro. Tavolino LOUIS laccato lucido nero. Chaise longue MOSCOVA BASSA dx in tessuto M150, Cat. C, colore 26.

MOZART bed upholstered in M150 fabric, Cat. C, col. 26, with H.15 bed frame with Marie base in Brown Ash. MARIE bedside table and chest of drawers in heat-treated oak and top in Calacatta Oro marble. LOUIS black glossy lacquered side table. MOSCOVA BASSA right chaise longue in M150 fabric, Cat. C, col. 26.











LETTO / BED

Il letto Mozart presenta una testata imbottita dall'aspetto confortevole e dallo stile essenziale. La Testata presenta una elegante lavorazione capitonné che rende il letto versatile per ogni ambiente. Il letto è disponibile sia nella versione giroletto contenitore che nella versione con piedi metallici o in legno massello.

The MOZART bed has a comfortable-looking padded headboard with an essential style. The headboard has an elegant capitonné style that makes the bed versatile for any environment. The bed is available both in the container bed frame version and in the version with metal or solid wood feet.

COMÒ / CHEST OF DRAWERS

Il comò MARIE rievoca linee leggere e contemporanee, la struttura è in legno massello impiallacciato con gole a 45 gradi per l'apertura cassetto. Il piano è disponibile in pregiato marmo o in vetro o legno.

The MARIE chest of drawers recalls light and contemporary lines. The structure is in solid wood veneer with 45 degree grooves for drawer opening. The top is available in precious marble, glass or wood.

CHAISE LONGUE

Un'eleganza sofisticata caratterizza la chaise longue MOSCOVA. La struttura imbottita rivestita in tessuto o pelle è disponibile in due diverse versioni di bracciolo dx e sx ed in due diverse versioni di base, una con piede metallico o in legno H.15 cm ed una con piedino a scomparsa H.4 cm.

Sophisticated elegance characterizes the MOSCOVA chaise longue. The upholstered structure covered in fabric or leather is available in two different versions of right and left armrest and in two different base versions, one with metal or wooden foot H.15 cm and one with retractable foot H.4 cm.

COMODINO / BED SIDE TABLE

Il comodino MARIE a un cassetto rievoca linee leggere e contemporanee, la struttura è in legno massello impiallacciato con gole a 45 gradi per l'apertura cassetto. Il piano è disponibile in pregiato marmo o in vetro o legno.

The MARIE bedside table with one drawer recalls light and contemporary lines. The structure is in solid wood veneer with 45 degree grooves for drawer opening. The top is available in precious marble, glass or wood.

TAVOLINO / SIDE TABLE

Il tavolino LOUIS presenta un'estetica essenziale e semplice con una struttura in legno massello stondata e smussata, il piano è laccato lucido Nero o Brown. I piedi sono in frassino verniciato in tinta con il piano.

The LOUIS side table has an essential and simple aesthetic with a rounded and beveled solid wood structure, the top is glossy lacquered Black or Brown. The feet are in ash painted in the same colour as the top.

MOZART

Struttura

In legno multistrato

Imbottitura

In poliuretano espanso ad alta densità

Rivestimento

In tessuto o pelle, parzialmente sfoderabile

Structure

In plywood

Padding

In high density polyurethane foam

Upholstery

In fabric or leather, partially removable

Misure europee / European sizes

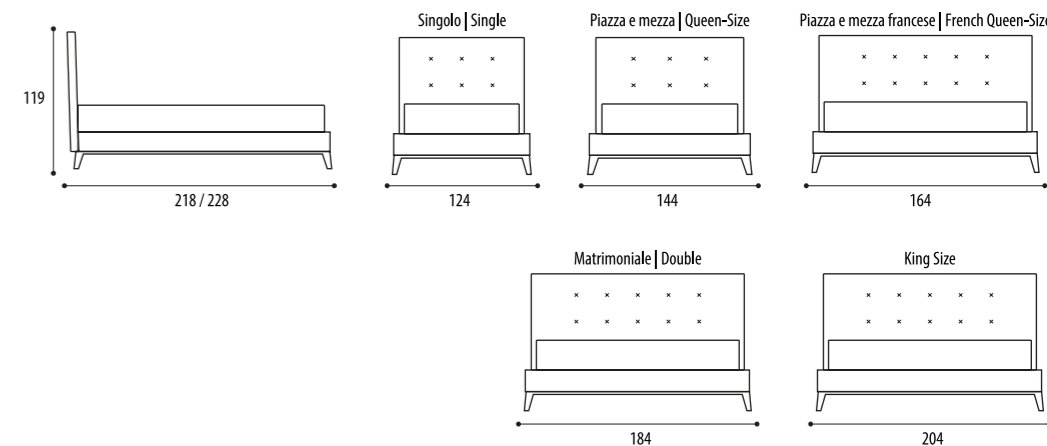

Misure americane / American Sizes

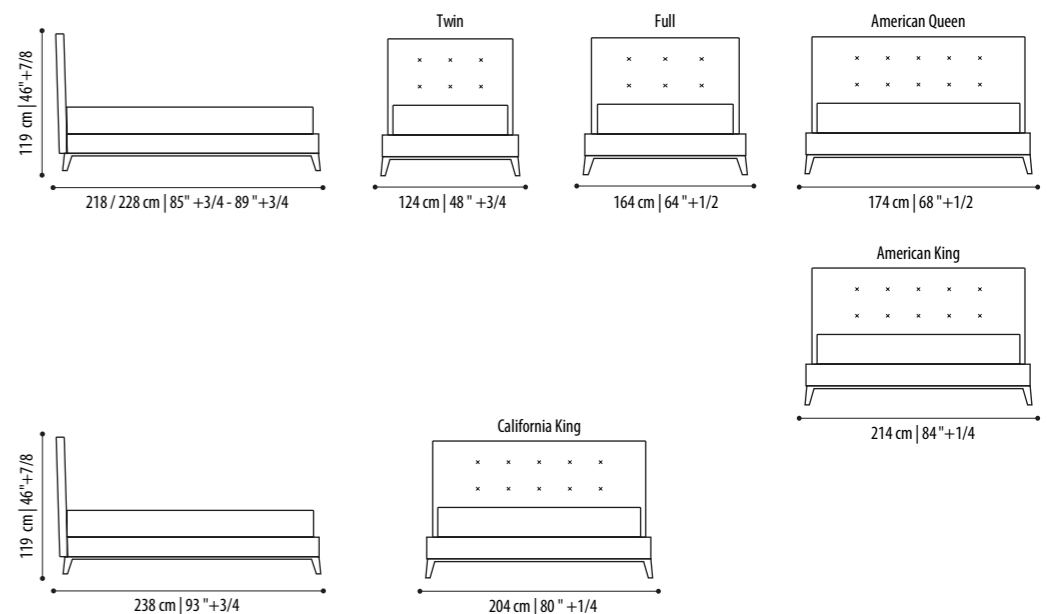

NUAGE

design Joe Garzone

Letto NUAGE, progettato da Joe Garzone, rivestito in pelle Nabuk, Cat. D, col. Grigio Chiaro, con pannelli laterali in Rovere Termotrattato e inserti in finitura Ottone. Coppia di comodini NUAGE MAXI a un cassetto in Rovere Termotrattato, maniglie in Ottone Brunito e piano in marmo Calacatta Oro. Comò HUGS in Ebano Scuro e dettagli in Ottone Brunito. Poltrona HUGS, in tessuto T 117/547, Cat. C, e struttura in Frassino Marrone con dettagli in Ottone Brunito. Panca MARIE in Frassino Marrone e Nabuk colore Grigio Chiaro. Specchio CIRCO con struttura verniciata Brown. Coppia di settimini NUAGE, in Rovere Termotrattato e piano in marmo Calacatta Oro. Chaise Longue MOSCOVA ALTA sx, in tessuto Magritte, Cat. C, col. 11.

NUAGE bed, designed by Joe Garzone, upholstered in Nabuk leather, Cat. D, Light Grey colour, with heat-treated oak side panels and inserts in Brass finish. Pair of NUAGE MAXI one-drawer bedside tables in heat-treated oak, handles in Bronzed Brass and top in Calacatta Oro marble. HUGS chest of drawers in Dark Ebony and details in Bronzed Brass. HUGS armchair, in fabric T117/547, Cat. C, and structure in Brown Ash with details in Bronzed Brass. MARIE bench in Brown Ash and Light Grey Nabuk. CIRCO mirror with Brown painted structure. NUAGE pair of chest of 7 drawers, in heat-treated oak and Calacatta Oro marble top. MOSCOVA HIGH left chaise longue, in Magritte fabric, Cat. C, col. 11.









LETTO / BED

Il letto NUAGE, progettato dall'architetto Joe Garzone, presenta degli eleganti e raffinati pannelli boiserie imbottiti nella parte centrale e due pannelli in legno disponibili in diverse finiture con dettagli in Ottone nella parte laterale. Tutte le parti imbottite sono sfoderabili e rendono il letto ideale per progetti contract e residenziali.

The NUAGE bed, designed by architect Joe Garzone, features elegant and refined padded boiserie panels in the central part and two wooden panels available in different finishes with Brass details on the side. All the padded parts are removable and make the bed ideal for contract and residential projects.

POLTRONA / ARMCHAIR

La poltrona HUGS è moderna, confortevole e raffinata. Il design essenziale della struttura in Frassino o Noce Canaletto stonato con dettagli in Ottone Brunito è in perfetta armonia con il rivestimento in tessuto o pelle sfoderabile della parte imbottita.

The HUGS armchair is modern, comfortable and refined. The essential design of the rounded structure in Ash or Canaletto Walnut with details in Bronzed Brass is in perfect harmony with the removable fabric or leather upholstery of the padded part.

COMÒ / CHEST OF DRAWERS

Il comò HUGS ha una struttura in legno con gole a 45 gradi ed è disponibile sia in versione impiallacciata in legno che in versione laccato lucido o opaco in diverse colorazioni. I piedi sono in legno massello verniciato e stonato con dettagli in Ottone Brunito o metallo verniciato.

The HUGS chest of drawers has a wooden structure with 45-degree grooves and is available both in a wood veneer version and in a glossy or matt lacquered version in different colours. The feet are in varnished and rounded solid wood with details in Bronzed Brass or varnished metal.

PANCA / BENCH

La panca MARIE, rievoca linee anni 50. La struttura in legno massello, supporta un cuscino rivestito in pelle o tessuto trapuntato con una leggera lavorazione capitonné.

The MARIE bench recalls lines of the 1950s. The solid wood structure supports a cushion upholstered in leather or quilted fabric with a light capitonné style.

SETTIMINO / CHEST OF 7 DRAWERS

Il settimano NUAGE disegnato dall'architetto Joe Garzone è l'ideale come soluzione salvaspazio contenitiva per la zona notte, il modello presenta una struttura in legno massello disponibile in diverse finiture in abbinamento a pregiati marmi o a piani in vetro e legno

The NUAGE chest of 7 drawers, designed by architect Joe Garzone, is ideal as a space-saving storage solution for the sleeping area. The model has a solid wood structure available in different finishes, combined with precious marbles or glass and wood tops.

COMODINO / BED SIDE TABLE

Il comodino NUAGE MAXI a un cassetto presenta una struttura in legno massello composta da un unico cassetto con maniglia in Ottone Brunito o metallo verniciato. Il piano è disponibile in marmo, vetro o legno.

The NUAGE MAXI bedside table with one drawer has a solid wood structure consisting of a single drawer with handle in Bronzed Brass or painted metal. The top is available in marble, glass or wood.

CHAISE LONGUE

Un'eleganza sofisticata caratterizza la chaise longue MOSCOVA. La struttura imbottita rivestita in tessuto o pelle è disponibile in due diverse versioni di bracciolo dx e sx ed in due diverse versioni di base, una con piede metallico o in legno H.15 cm ed una con piedino a scomparsa H.4 cm.

Sophisticated elegance characterizes the MOSCOVA chaise longue. The upholstered structure covered in fabric or leather is available in two different versions of right and left armrest and in two different base versions, one with metal or wooden foot H.15 cm and one with retractable foot H.4 cm.

SPECCHIO / MIRROR

La struttura geometrica dello specchio CIRCO arreda con eleganza ogni ambiente ed è disponibile nelle finiture Brown o Ottone Brunito.

The geometric structure of the CIRCO mirror elegantly furnishes any environment and is available in Brown or Burnished Brass finishes.

NUAGE

Struttura

Legno impiallacciato in diverse essenze con dettagli in ottone

Imbottitura

In poliuretano espanso ad alta densità

Rivestimento

In tessuto o pelle, non sfoderabile

Structure

Wood veneered in different essences with brass details

Padding

In high density polyurethane foam

Upholstery

In fabric or leather, non-removable

Misure europee / European sizes

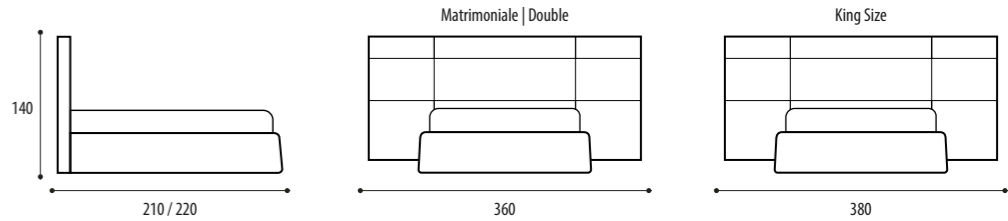

Misure americane / American Sizes

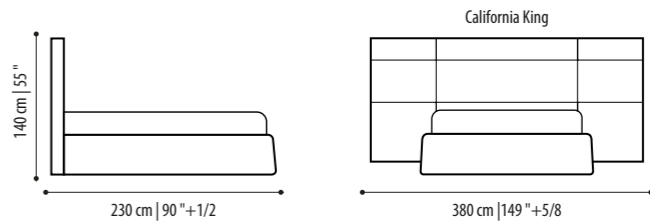
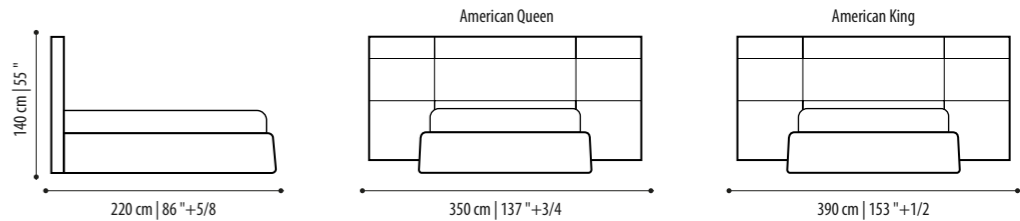

CHARLIE

design Joe Garzone

Letto CHARLIE, progettato dall'architetto Joe Garzone, in pelle Nabuk, cat. D, colore Conchiglia. Coppia di tavolini CHARLIE verniciati Brown e piano in vetro Fumé. Comò CHARLIE a tre cassetti in Rovere Termotrattato con maniglie Nickel e piano in marmo Calacatta Oro. Panca LOUIS in Ebano Scuro. Poltrona HUGS con struttura in Frassino Marrone e dettagli in Ottone Brunito, rivestimento in tessuto T 117/547, cat. C.

CHARLIE bed, designed by architect Joe Garzone, in Nabuk leather, cat. D, Conchiglia colour. Pair of CHARLIE side tables painted Brown and smoked glass top. CHARLIE chest of drawers with three drawers in Heat Treated Oak with Nickel handles and Calacatta Oro marble top. LOUIS bench in Dark Ebony. HUGS armchair with structure in Brown Ash and details in Bronzed Brass, upholstery in T117/547 fabric, cat. C.











LETTO / BED

Il letto CHARLIE, disegnato dall'architetto Joe Garzone, presenta forme imponenti e lineari. La lavorazione capitonné ne impreziosisce la testata e lo rende uno dei modelli più eleganti della gamma. Il letto è completamente rivestito in pelle o tessuto ed è parzialmente sfoderabile.

The CHARLIE bed, designed by architect Joe Garzone, has imposing and linear shapes. The capitonné style embellishes the headboard and makes it one of the most elegant models in the range. The bed is completely upholstered in leather or fabric and is partially removable.

TAVOLINO / SIDE TABLE

Il tavolino CHARLIE presenta una solida struttura metallica verniciata a cui è possibile abbinare diverse finiture di piani in marmo o vetro.

The CHARLIE side table has a solid painted metal structure to which it is possible to combine different finishes of marble or glass tops.

COMÒ / CHEST OF DRAWERS

Il comò CHARLIE disegnato da Joe Garzone ha una struttura curvata in legno massello che ne esaltano le forme e lo stile. Il piano è configurabile in diverse essenze di legno o diverse colorazioni di marmo e vetro, le maniglie sono in metallo o in Ottone Brunito. Il modello è disponibile nella versione a tre o a quattro cassetti.

The CHARLIE chest of drawers, designed by Joe Garzone, has a curved solid wood structure that enhances its shapes and style. The top can be configured in different wood essences or different colours of marble and glass, the handles are in metal or in Bronzed Brass. The model is available in the version with three or four drawers.

PANCA / BENCH

La panca LOUIS è in legno massello impiallacciato disponibile in oltre 5 essenze di legno, mentre i piedi sono in legno massello stondato e verniciato

The LOUIS bench is in veneered solid wood available in over 5 wood essences, while the feet are in rounded and varnished solid wood.

POLTRONA / ARMCHAIR

La poltrona HUGS è moderna, confortevole e raffinata. Il design essenziale della struttura in Frassino o Noce Canaletto stondato con dettagli in Ottone Brunito è in perfetta armonia con il rivestimento in tessuto o pelle sfoderabile della parte imbottita.

The HUGS armchair is modern, comfortable and refined. The essential design of the rounded structure in Ash or Canaletto Walnut with details in Bronzed Brass is in perfect harmony with the removable fabric or leather upholstery of the padded part.

CHARLIE

Struttura

Legno multistrato

Imbottitura

In poliuretano espanso ad alta densità

Rivestimento

In tessuto o pelle, parzialmente sfoderabile

Structure

In plywood

Padding

In high density polyurethane foam

Upholstery

In fabric or leather, partially removable

Misure europee / European sizes

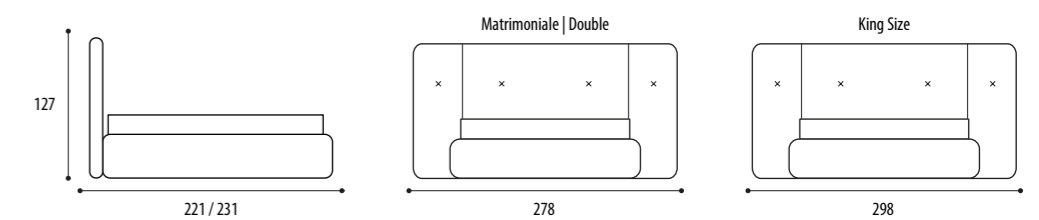

Misure americane / American Sizes

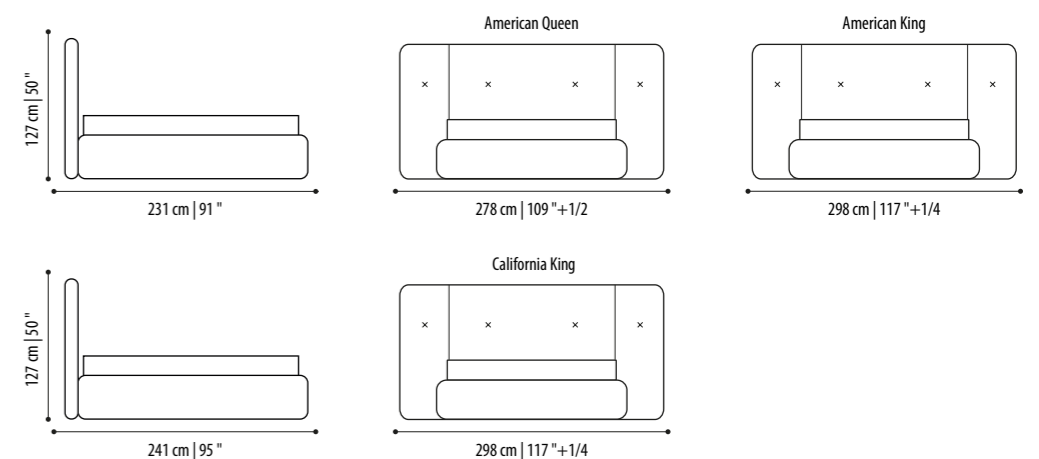

AVENUE

design Joe Garzone

Letto AVENUE, disegnato dall'architetto Joe Garzone, rivestito in tessuto T172/09 Scuro, cat. C, ring H.15 con base pressofusa Avenue in colore Bronzo. Comò e comodino AVENUE laccato lucido colore nero, con base Avenue Bronzo. Tavolino VERSAILLES nero con piano in marmo Sahara Black. Poltrona KARL in tessuto Vega, cat. C, colore 76. Panca AVENUE in tessuto T172/09 Scuro e base Avenue pressofusa in colore Bronzo.

AVENUE bed, designed by architect Joe Garzone, upholstered in T172/09 Dark fabric, cat. C, ring H.15 with Avenue die-cast base in Bronze colour. AVENUE chest of drawers and bedside table in glossy black lacquer, with Avenue Bronzo base. VERSAILLES black side table with Sahara Black marble top. KARL armchair in Vega fabric, cat. C, col. 76. AVENUE bench in T172/09 Dark fabric and Avenue die-cast base in Bronze colour.











LETTO / BED

Il letto AVENUE, disegnato dall'architetto Joe Garzone, presenta una testata imbottita dall'aspetto confortevole e dallo stile essenziale, impreziosita dalle cuciture sulla testiera. La base è in metallo pressofuso ed è disponibile in due diverse colorazioni.

The AVENUE bed, designed by architect Joe Garzone, features an upholstered headboard with a comfortable look and an essential style, embellished by the stitching on the headboard. The base is in die-cast metal and is available in two different colours.

POLTRONA / ARMCHAIR

La poltrona KARL si caratterizza per le linee armoniche e avvolgenti con una struttura schiumata in poliuretano ad alta densità con più di 500 varianti di rivestimento in tessuto o pelle. I piedi sono in legno massello verniciato Brown o Black.

The KARL armchair is characterized by harmonious and enveloping lines with a high-density polyurethane foam structure with more than 500 variants of fabric or leather upholstery. The feet are in Brown or Black varnished solid wood.

COMÒ / CHEST OF DRAWERS

Il comò AVENUE ha un design moderno ed essenziale. La struttura è in legno impiallacciato o laccato lucido e opaco con gole a 45 gradi per l'apertura cassetto. La base è in metallo pressofuso in due diverse colorazioni.

The AVENUE chest of drawers has a modern and essential design. The structure is in veneered wood or glossy and matt lacquer with 45-degree grooves for drawer opening. The base is in die-cast metal and is available in two different colours.

COMODINO / BED SIDE TABLE

Il comodino AVENUE ha un design moderno ed essenziale. La struttura è in legno impiallacciato o laccato lucido e opaco con gole a 45 gradi per l'apertura cassetto. La base è in metallo pressofuso in due diverse colorazioni.

The AVENUE bedside table has a modern and essential design. The structure is in veneered wood or glossy and matt lacquer with 45-degree grooves for drawer opening. The base is in die-cast metal and is available in two different colours.

PANCA / BENCH

La panca AVENUE rievoca linee leggere e contemporanee. La base Avenue in metallo pressofuso supporta un morbido cuscino in poliuretano rivestito in tessuto o pelle.

The AVENUE bench recalls light and contemporary lines. The Avenue base in die-cast metal supports a soft polyurethane cushion upholstered in fabric or leather.

TAVOLINO / SIDE TABLE

Il tavolino VERSAILLES presenta un'estetica essenziale con una struttura in metallo verniciato con piano in marmo o vetro in diverse finiture.

The VERSAILLES side table has an essential aesthetic with a painted metal structure with marble or glass top in different finishes.

AVENUE

Struttura

In legno multistrato e base in metallo pressofuso in diverse colorazioni

Imbottitura

In poliuretano espanso ad alta densità

Rivestimento

In tessuto o pelle, non sfoderabile

Structure

In plywood and die-cast metal base in different colours

Padding

In high density polyurethane foam

Upholstery

In fabric or leather, non-removable

Misure europee / European sizes

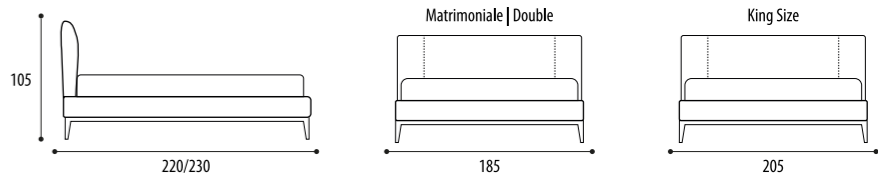

Misure americane / American Sizes

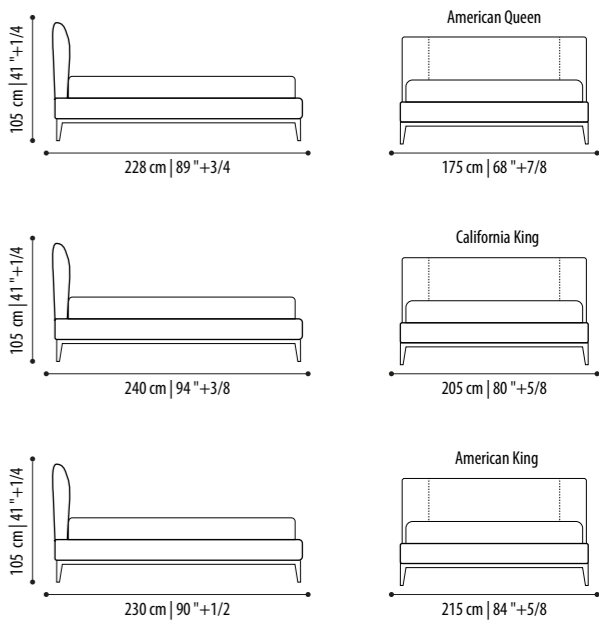

MICHELANGELO

design Conte Studio

Letto MICHELANGELO, in tessuto Vegas, cat. C, colore o6, con ring H.15 e base MARIE in Frassino Nero. Coppia di comodini CHARLIE a un cassetto, in Ebano Scuro con maniglie in Ottone Brunito. Poltrona e pouf QUEEN rivestiti in tessuto T/117/223, cat. C, e piedi in legno massello verniciati colore Nero. Scrivitoio IRON con piano in Nabuk colore Sabbia e struttura in metallo Antracite con dettagli e specchio in Ottone Brunito. Pouf PARIS in pelle Nabuk col. Sabbia e base in metallo Antracite.

MICHELANGELO bed, in Vegas fabric, cat. C, col. o6, with H.15 ring and MARIE base in Black Ash. Pair of CHARLIE bedside tables with one drawer, in Dark Ebony with handles in Bronzed Brass. QUEEN armchair and pouf upholstered in fabric T/117/223, cat. C, and feet in solid wood painted Black. IRON writing desk with Nabuk top, Sabbia colour and Anthracite metal structure with details and mirror in Bronzed Brass. PARIS pouf in Nabuk leather, Sabbia colour and Anthracite metal base.











LETTO / BED

Il letto MICHELANGELO, disegnato da Joe Garzone, presenta una grande e importante testata a boiserie formata da diversi pannelli sfoderabili e componibili, configurabili in diverse dimensioni, ideale per progetti contract e residenziali. Il letto è disponibile anche con giroletto con rete contenitore.

The MICHELANGELO bed, designed by Joe Garzone, features a large and important boiserie headboard made up of several removable and modular panels, configurable in different sizes, ideal for contract and residential projects. The bed is also available with container bed frame.

POLTRONA / ARMCHAIR

La poltrona QUEEN si caratterizza per le linee armoniche e avvolgenti con una struttura schiumata in poliuretano ad alta densità con più di 500 varianti di rivestimento in tessuto o pelle. I piedi sono in legno massello verniciato Brown o Black.

The QUEEN armchair is characterized by harmonious and enveloping lines with a high-density polyurethane foam structure, with more than 500 variants of fabric or leather upholstery. The feet are in Brown or Black varnished solid wood.

COMODINO / BED SIDE TABLE

Il comodino CHARLIE ha linee sinuose e delicate. Composto da una struttura curvata in legno massello e disponibile nelle versioni a uno o due cassetti, i piani sono disponibili in diverse finiture di marmo, vetro o legno. le maniglie dei cassetti sono in metallo verniciato o Ottone Brunito.

The CHARLIE bedside table has sinuous and delicate lines. Composed of a curved solid wood structure, it is available in versions with one or two drawers. The tops are available in different finishes in marble, glass or wood. The drawer handles are in painted metal or Bronzed Brass.

SCRITTOIO / WRITING DESK

Lo scrittoio IRON progettato da Joe Garzone ha linee eleganti e profili delicati. Il piano è disponibile in pelle Nabuk o eco Nabuk lavabile e smacchiabile, la struttura è in acciaio verniciata color Antracite con dettagli e specchio in Ottone Brunito.

The IRON writing desk, designed by Joe Garzone, has elegant lines and delicate profiles. The top is available in washable and stain-resistant Nabuk or eco-Nabuk leather, the structure is in anthracite painted steel with details and mirror in Bronzed Brass.

POUF

Il pouf QUEEN è composto da una struttura schiumata in poliuretano ed una base in legno massello disponibile nelle colorazioni Brown e Black.

Il pouf PARIS è uno dei più eleganti della gamma grazie alla preziosa lavorazione capitonné, la base è disponibile in Ottone Brunito o in metallo verniciato.

The QUEEN pouf is composed of a polyurethane foam structure and a solid wood base available in Brown and Black colours.

The PARIS pouf is one of the most elegant in the range thanks to the precious capitonné style. The base is available in Bronzed Brass or painted metal.

MICHELANGELO

Struttura

In legno multistrato

Imbottitura

In poliuretano espanso ad alta densità

Rivestimento

In tessuto o pelle, non sfoderabile

Structure

In plywood

Padding

In high density polyurethane foam

Upholstery

In fabric or leather, non-removable

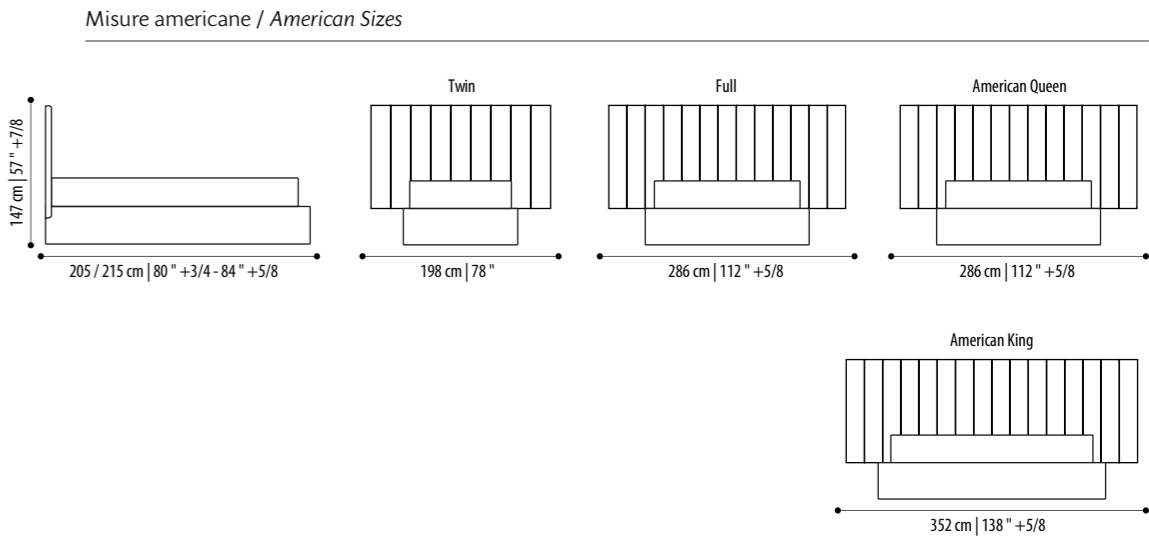
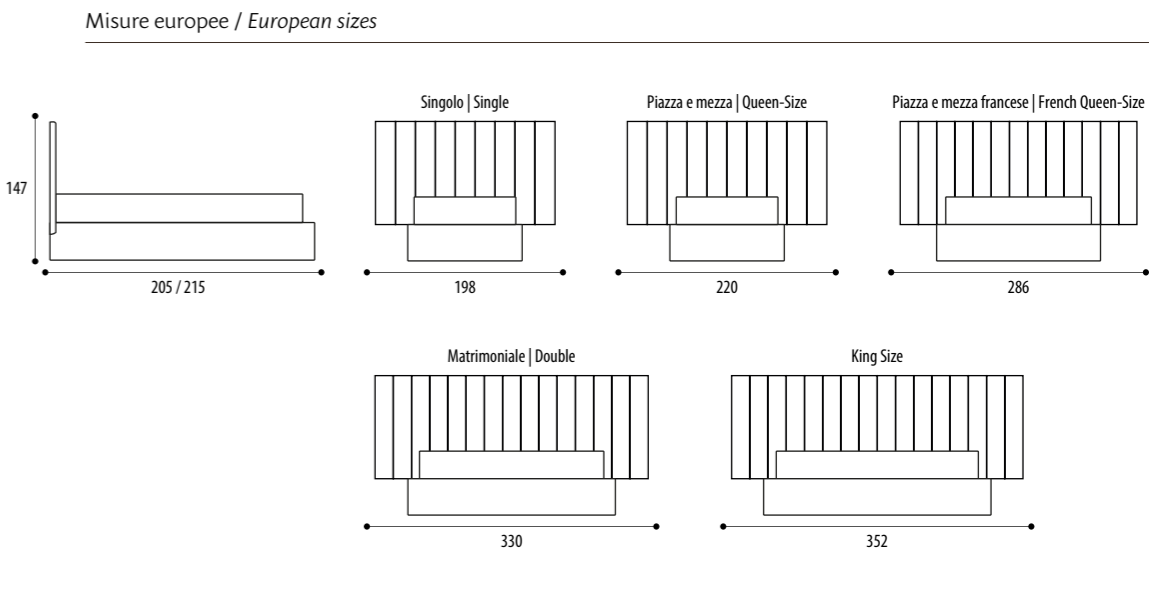

RANIA

design Conte Studio

Letto RANIA con ring H.30, rivestito in tessuto G 172/09 S, cat. C, con cucitura a contrasto color ruggine. Comodino NUAGE MAXI in Ebano Scuro, maniglie Brown e piano in marmo Sahara Black. Comodino MARIE in Ebano Scuro con piano in marmo Sahara Black. Poltrona KARL in tessuto Vegas, cat. C, colore 76.

RANIA bed with ring H.30, covered in fabric G172/09 S, cat. C, with contrasting Rust colour stitching. NUAGE MAXI bedside table in Dark Ebony, Brown handles and Sahara Black marble top. MARIE bedside table in Dark Ebony with Sahara Black marble top. KARL armchair in Vegas fabric, cat. C, col. 76.









LETTO / BED

Rania è un letto con testata imbottita dall'aspetto confortevole e dallo stile informale. La testata è caratterizzata dalle cuciture a contrasto e dalle dimensioni contenute della testata. Il letto è disponibile in versione con giroletto contenitore o con giroletto con piedi metallici o in legno massello.

RANIA is a bed with an upholstered headboard with a comfortable look and an informal style. The headboard is characterized by contrasting stitching and the small size of the headboard. The bed is available in a version with a container bed frame or with a bed frame with metal or solid wood feet.

COMODINO / BED SIDE TABLE

Il comodino NUAGE MAXI a un cassetto presenta una struttura in legno massello composta da un unico cassetto con maniglia in Ottone Brunito o metallo verniciato. Il piano è disponibile in marmo, vetro o legno.

Il comodino MARIE a un cassetto rievoca linee leggere e contemporanee, la struttura è in legno massello impiallacciato con gole a 45 gradi per l'apertura cassetto. Il piano è disponibile in pregiato marmo o in vetro o legno

The NUAGE MAXI bedside table with one drawer has a solid wood structure consisting of a single drawer with handle in Bronzed Brass or painted metal. The top is available in precious marble, glass or wood.

The MARIE bedside table with one drawer recalls light and contemporary lines. The structure is in solid wood veneer with 45 degree grooves for drawer opening. The top is available in precious marble, glass or wood.

RANIA

Struttura

In legno multistrato

Imbottitura

In poliuretano espanso ad alta densità

Rivestimento

In tessuto o pelle, parzialmente sfoderabile, con cucitura o bordino in pelle a contrasto in diverse colorazioni

Structure

In plywood

Padding

In high density polyurethane foam

Upholstery

In fabric or leather, partially removable, with stitching or border in contrasting leather in different colours

Misure europee / European sizes

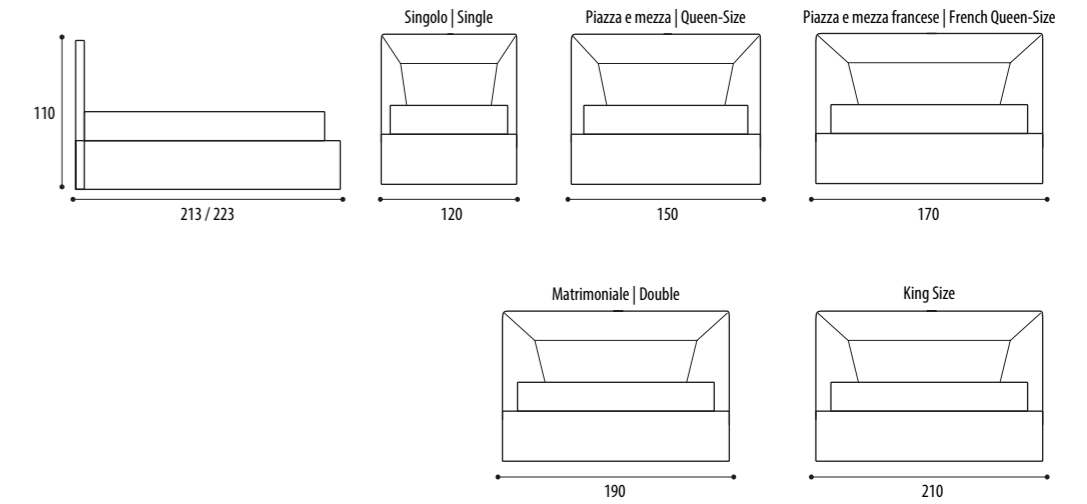

Misure americane / American Sizes

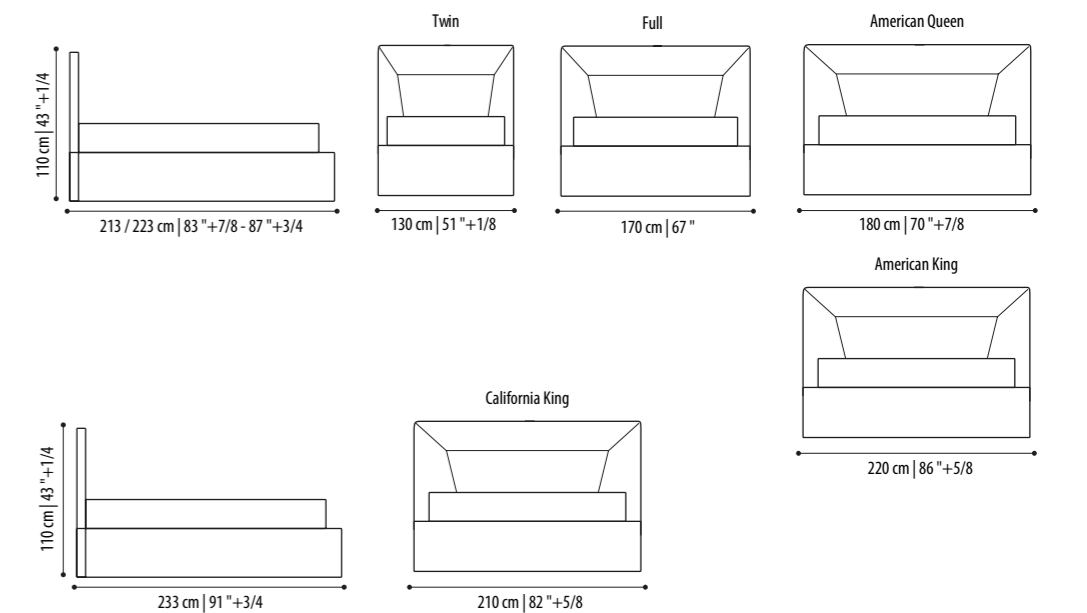

IVONNE ROYAL

design Conte Studio

Letto IVONNE ROYAL con lavorazione capitonné, ring H.30 e rivestimento in tessuto Vegas, cat. C, col. 76. Coppia di tavolini IRON BASSO con struttura in metallo Antracite e piano in marmo Georgette. Comò CHARLIE versione quattro cassetti in Rovere Termotrattato, piano in marmo Calacatta Oro e maniglie Nickel. Panca CORBUSIER con piede nickel e cuscino in tessuto Vegas, cat. C, colore 76. Poltrona HUGS in frassino marrone e particolari in Ottone Brunito, rivestita in tessuto Vegas, cat. C, colore 41. Specchio CIRCO con struttura in Ottone Brunito.

IVONNE ROYAL bed with capitonné style, ring H.30 and Vegas fabric upholstery, cat. C, col. 76. Pair of IRON BASSO side tables with anthracite metal structure and Georgette marble top. CHARLIE chest of drawers, four-drawer version in Heat-Treated Oak, Calacatta Oro marble top and Nickel handles. CORBUSIER bench with nickel foot and cushion in Vegas fabric, cat. C, col. 76. HUGS armchair in Brown Ash and details in Bronzed Brass, upholstered in Vegas fabric, cat. C, col. 41. CIRCO mirror with Bronzed Brass structure.













LETTO / BED

Il letto IVONNE ROYAL presenta una importante testiera con la preziosa lavorazione capitonné. Rendendo il letto uno dei più eleganti della gamma. Il modello IVONNE è disponibile anche nella versione con spalla più stretta per ambienti più contenuti.

The IVONNE ROYAL bed has an important headboard with the precious capitonné style, which makes it one of the most elegant in the range. The IVONNE model is also available in the version with a narrower shoulder for smaller spaces.

POLTRONA / ARMCHAIR

La poltrona HUGS è moderna, confortevole e raffinata. Il design essenziale della struttura in Frassino o Noce Canaletto stondato con dettagli in Ottone Brunito è in perfetta armonia con il rivestimento in tessuto o pelle sfoderabile della parte imbottita.

The HUGS armchair is modern, comfortable and refined. The essential design of the rounded structure in Ash or Canaletto Walnut with details in Bronzed Brass is in perfect harmony with the removable fabric or leather upholstery of the padded part.

COMÒ / CHEST OF DRAWERS

Il comò CHARLIE disegnato da Joe Garzone ha una struttura curvata in legno massello che ne esaltano le forme e lo stile. Il piano è configurabile in diverse essenze di legno o diverse colorazioni di marmo e vetro, le maniglie sono in metallo o in Ottone Brunito. Il modello è disponibile nella versione a tre o a quattro cassetti.

The CHARLIE chest of drawers, designed by Joe Garzone, has a curved solid wood structure that enhances its shapes and style. The top can be configured in different wood essences or different colours of marble and glass, the handles are in metal or in Bronzed Brass. The model is available in the version with three or four drawers.

PANCA / BENCH

La panca CORBUSIER è caratterizzata dall'elegante lavorazione capitonné sul cuscino supportato da una base metallica verniciata in diverse finiture.

The CORBUSIER bench is characterized by the elegant capitonné style on the cushion supported by a metal base painted in different finishes.

SPECCHIO / MIRROR

La struttura geometrica dello specchio CIRCO arreda con eleganza ogni ambiente ed è disponibile nelle finiture Brown o Ottone Brunito.

The geometric structure of the CIRCO mirror elegantly furnishes any environment and is available in Brown or Burnished Brass finishes.

TAVOLINO / SIDE TABLE

Il tavolino IRON BASSO presenta una struttura in metallo con piano in marmo a scelta.

The IRON BASSO side table has a metal structure and marble top in different finishes.

IVONNE ROYAL

Struttura

In legno multistrato

Imbottitura

In poliuretano espanso ad alta densità

Rivestimento

In tessuto o pelle, non sfoderabile

Structure

In plywood

Padding

In high density polyurethane foam

Upholstery

In fabric or leather, non-removable

Misure europee / European sizes

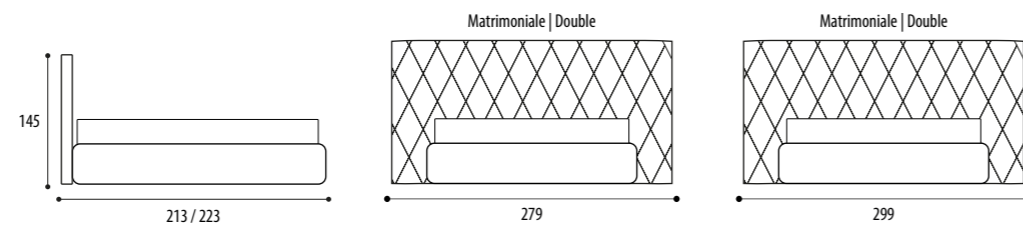

Misure americane / American Sizes

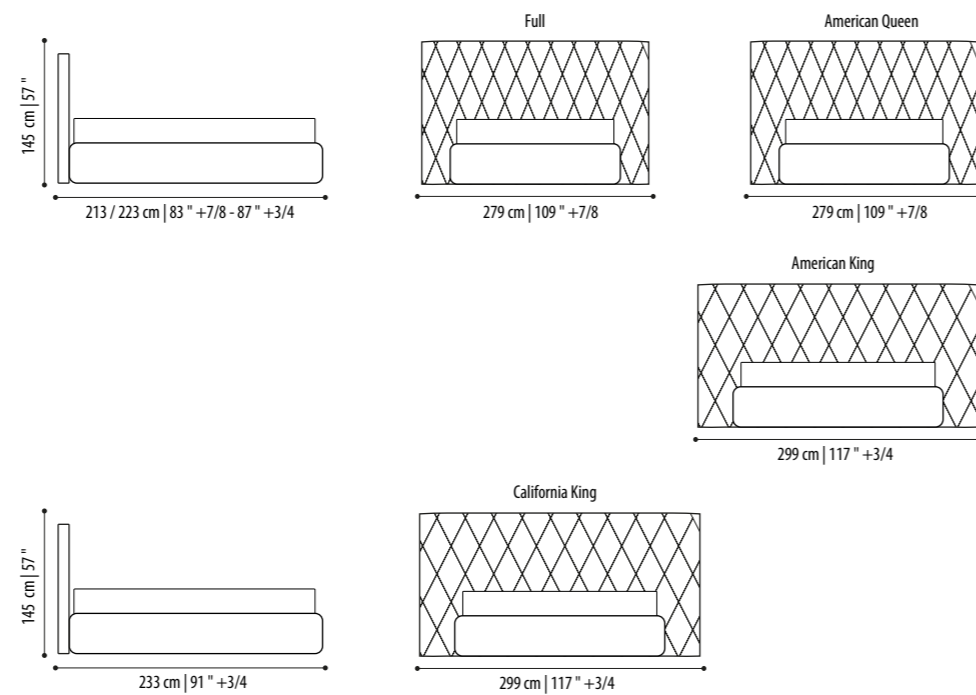

IVONNE

Struttura

In legno multistrato

Imbottitura

In poliuretano espanso ad alta densità

Rivestimento

In tessuto o pelle, non sfoderabile

Structure

In plywood

Padding

In high density polyurethane foam

Upholstery

In fabric or leather, non-removable

Misure europee / European sizes

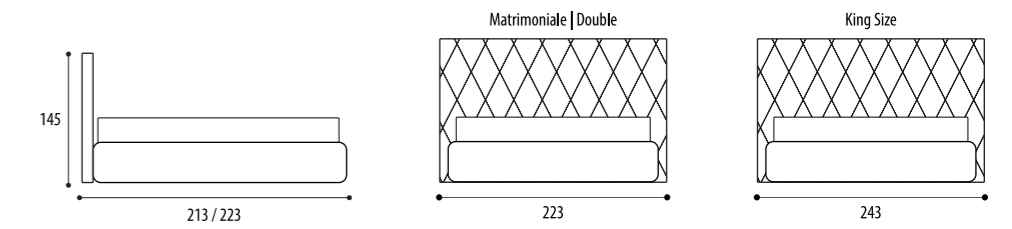

Misure americane / American Sizes

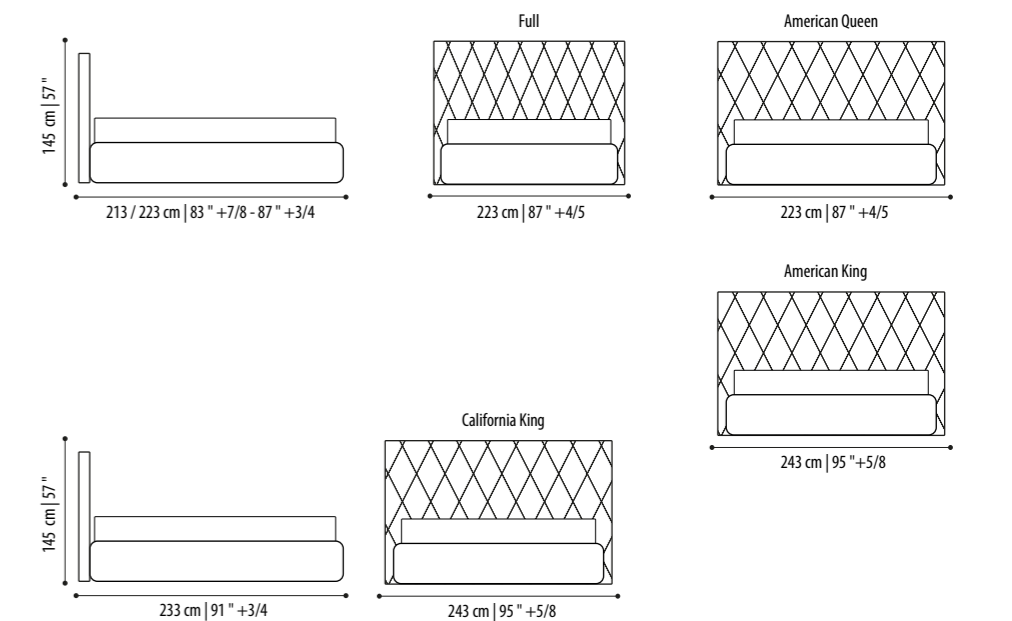

MOSCOVA

design Joe Garzone

Letto MOSCOVA con ring H.15, con piede Eiffel nero, rivestito con tessuto Kos col. 10, cat. B. Comodino NUAGE in rovere Termotrattato e piano in marmo Calacatta Oro con maniglie in ottone Brunito. Poltrona CHELSEA in tessuto G 172/09 s con base girevole in frassino black.

MOSCOVA bed with ring H. 15, with black Eiffel foot, upholstered with Milos fabric col. 10, cat. B. NUAGE bedside table in heat-treated oak and Calacatta Oro marble top with bronzed brass handles. CHELSEA armchair in G 172/09 s fabric with swivel base in black ash.









LETTO / BED

Il letto MOSCOVA è un letto con testata imbottita confortevole e versatile per ogni ambiente. La testata, dalle dimensioni contenute, è caratterizzata dalla lavorazione capitonné. Il letto è disponibile in variante con giroletto contenitore o con piedini metallici o in legno.

The MOSCOVA bed is a bed with a comfortable and versatile padded headboard for any environment. The small size headboard is characterized by the capitonné style. The bed is available in a variant with container bed frame or with metal or wooden feet.

COMODINO / BED SIDE TABLE

Il comodino NUAGE a due cassetti, presenta una struttura in rovere termotrattato, con maniglia in Ottone Brunito o metallo verniciato. Il piano è disponibile in marmo, vetro o legno.

The NUAGE bedside table with one drawer has a solid wood structure consisting of a single drawer with handle in Bronzed Brass or painted metal. The top is available in marble, glass or wood.

PANCA / BENCH

La panca CHARLIE è impreziosita dalla sartorialità delle cuciture che ne sottolineano comodità e morbidezza. Il modello è disponibile con rivestimento in pelle o tessuto.

The CHARLIE bench is embellished by the tailoring of the seams that underline its comfort and softness. The model is available with leather or fabric upholstery.

POLTRONA / ARMCHAIR

La poltrona CHELSEA si caratterizza per le linee armoniche e avvolgenti, con una struttura schiumata in poliuretano ad alta densità. La poltrona è disponibile con più di 500 varianti di rivestimento in tessuto o in pelle. I piedi sono in legno massello verniciato Brown o Black.

The CHELSEA armchair is characterized by harmonious and enveloping lines, with a high-density polyurethane foam structure. The armchair is available with more than 500 variants of fabric or leather upholstery. The feet are in Brown or Black varnished solid wood.

MOSCOVA

Struttura

In legno multistrato

Imbottitura

In poliuretano espanso ad alta densità

Rivestimento

In tessuto o pelle, parzialmente sfoderabile

Structure

In plywood

Padding

In high density polyurethane foam

Upholstery

In fabric or leather, partially removable

Misure europee / European sizes

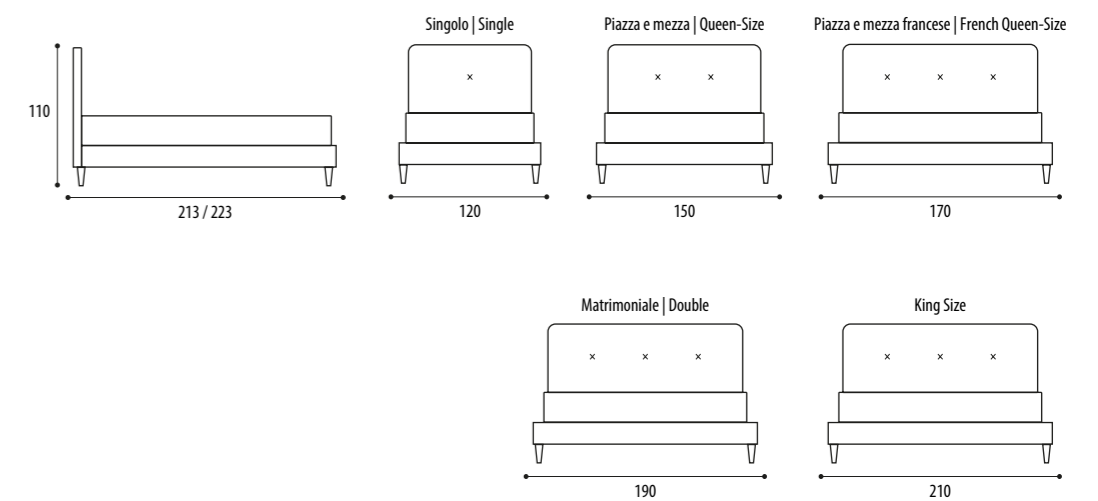

Misure americane / American Sizes

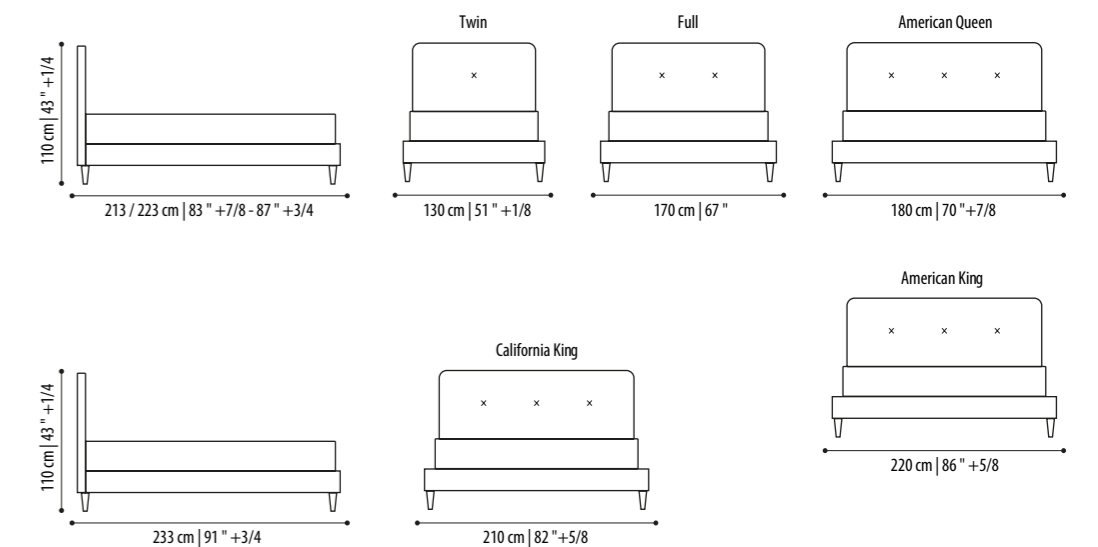

DUPLEX

design Conte Studio

Divano letto DUPLEX con seconda rete estraibile e materassi inclusi, disponibile in diverse varianti. Rivestimento in tessuto Borea, cat. B, colore 9502, con bordino a contrasto in tessuto Borea colore 9981.

DUPLEX sofa bed with second pull-out bed base and mattresses included, available in different variants. Upholstery in Borea fabric, cat. B, colour 9502, with contrasting border in Borea fabric colour 9981.





DUPLEX

Struttura

In legno multistrato e metallo

Imbottitura

In poliuretano espanso ad alta densità

Rivestimento

In tessuto o pelle, non sfoderabile

Extra

Disponibile in versione contenitore o con materasso estraibile

Structure

In plywood and metal

Padding

In high density polyurethane foam

Upholstery

In fabric or leather, non-removable

Extra

Available in container version or with removable mattress

Duplex Sommier

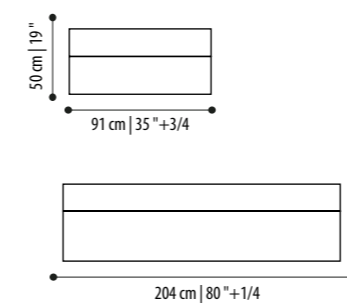

Duplex Lateral Storage Box

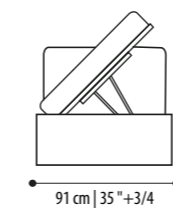

Duplex 1 - cx

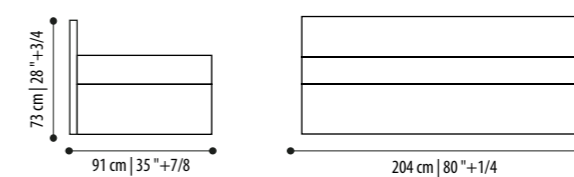

Duplex 1 - sx

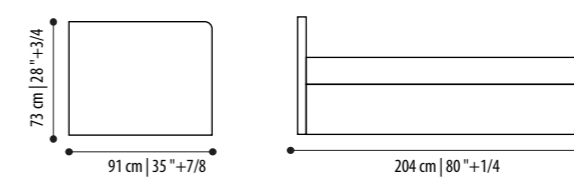

Duplex 2 - sx cx

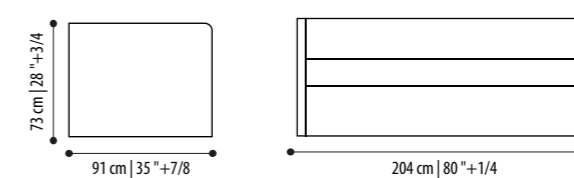

Duplex 2 sagomato - sx cx

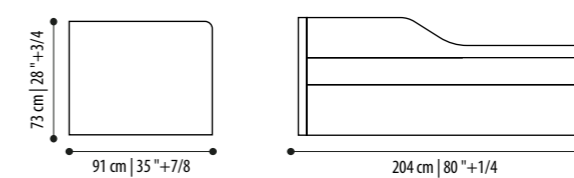

Duplex 3

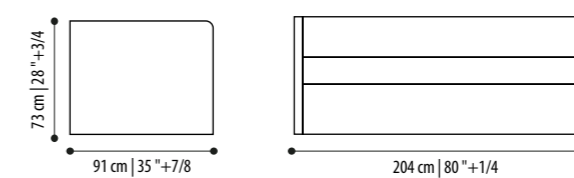

Duplex 1 - dx

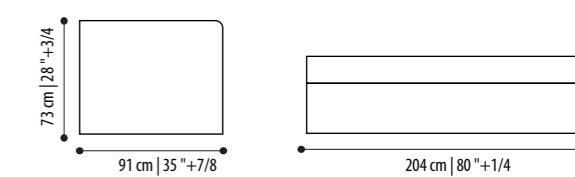

Duplex 2 sagomato - dx cx

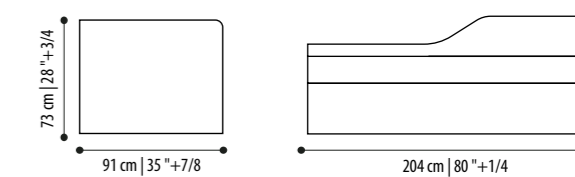

Duplex 2 - dx cx

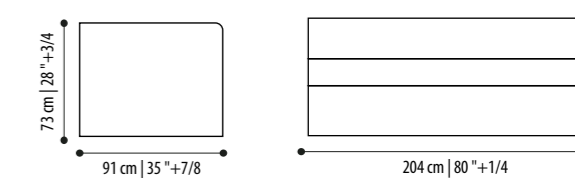

Duplex 2 - dx sx

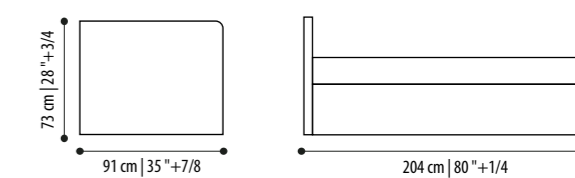

Duplex Sofà

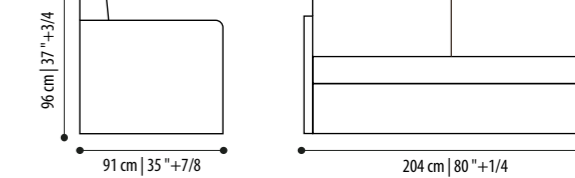



COMPLEMENTI

INFORMAZIONI TECNICHE / TECHNICAL SHEETS

CHARLIE

design Joe Garzone



Struttura

In legno curvato impiallacciato, in diverse essenze

Cassetti

Interno in legno impiallacciato, effetto pelle

Piano

In legno, vetro o marmo in diverse finiture

Maniglie

In ottone o metallo verniciato in diverse finiture

Structure

In curved veneered wood, in different essences

Drawers

Interior in veneered wood, leather effect

Top

In wood, glass or marble in different finishes

Handles

In brass or painted metal in different finishes

Comodino / Bedside table

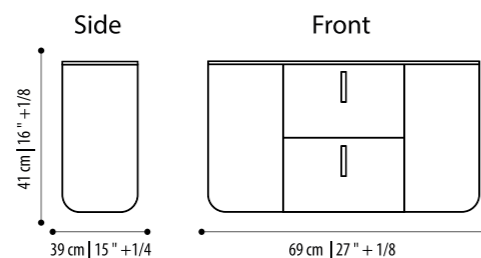
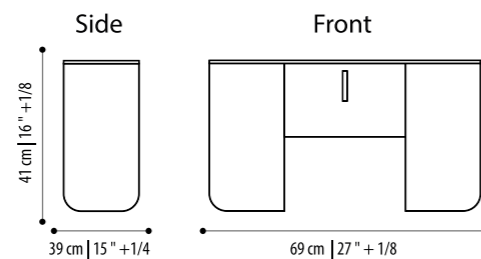

Comò / Chest of drawers

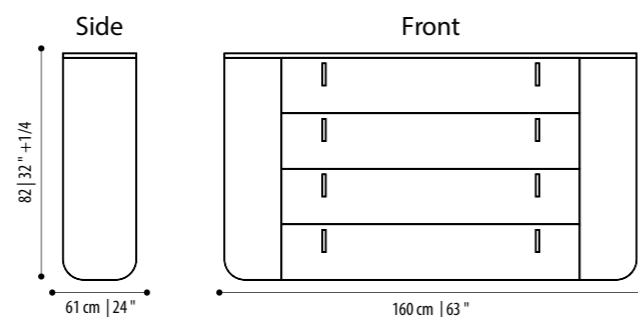
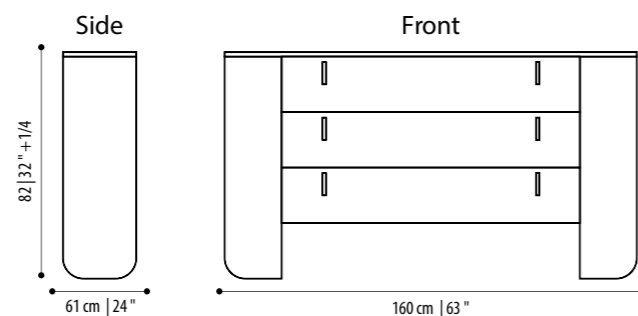

NUAGE

design Joe Garzone



Struttura

In legno impiallacciato e legno massello in diverse essenze

Cassetti

Interno in legno impiallacciato, effetto pelle

Piano

In legno, vetro o marmo in diverse finiture

Maniglie

In ottone o metallo verniciato in diverse finiture

Structure

In veneered wood and solid wood in different essences

Drawers

Interior in veneered wood, leather effect

Top

In wood, glass or marble in different finishes

Handles

In brass or painted metal in different finishes

Settimino / Chest of 7 drawers

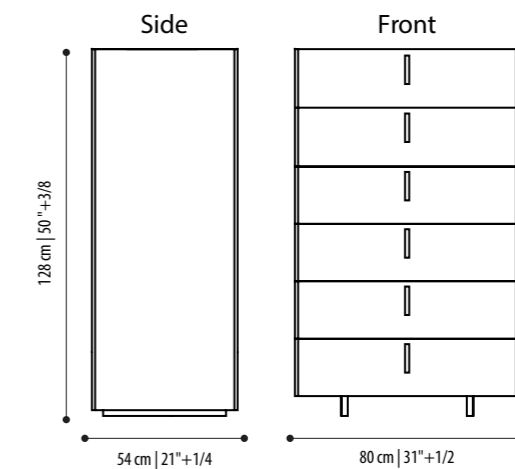

Comò / Chest of drawers

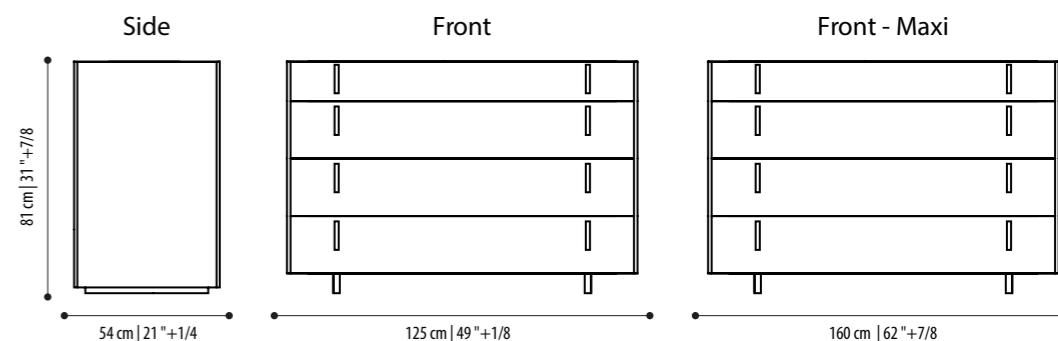

Comodino / Bedside table

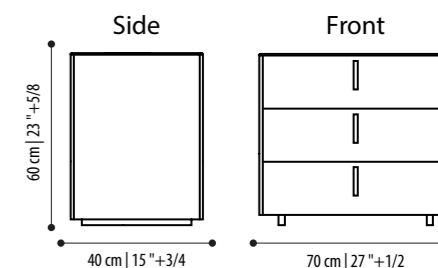
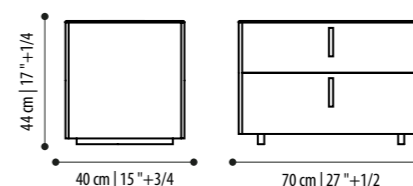
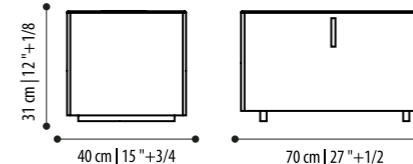
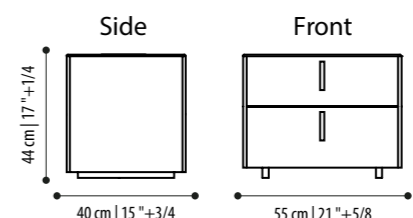

MARIE

design Joe Garzone



Struttura

In legno impiallacciato e legno massello in diverse essenze

Cassetti

Interno in legno impiallacciato, effetto pelle

Piano

In legno, vetro o marmo in diverse finiture

Structure

In veneered wood and solid wood in different essences

Drawers

Interior in veneered wood, leather effect

Top

In wood, glass or marble in different finishes

Settimino / Chest of 7 drawers

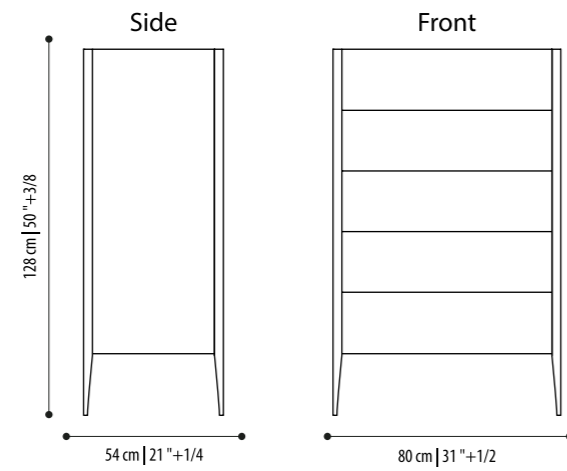

Comò / Chest of drawers

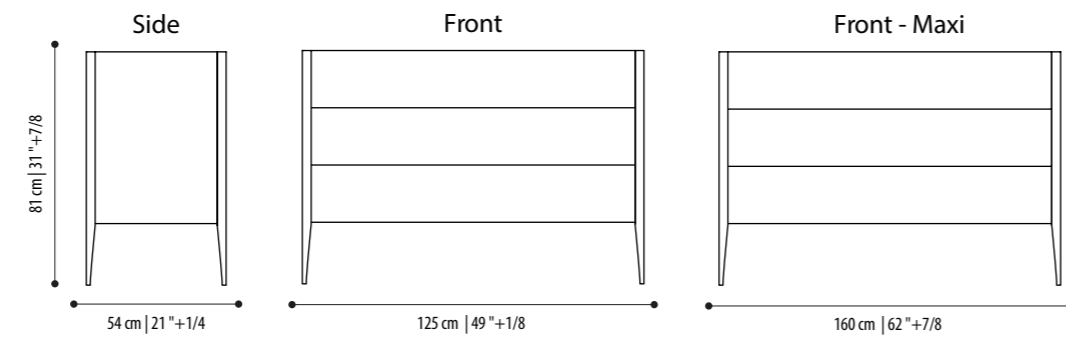

Comodino / Bedside table

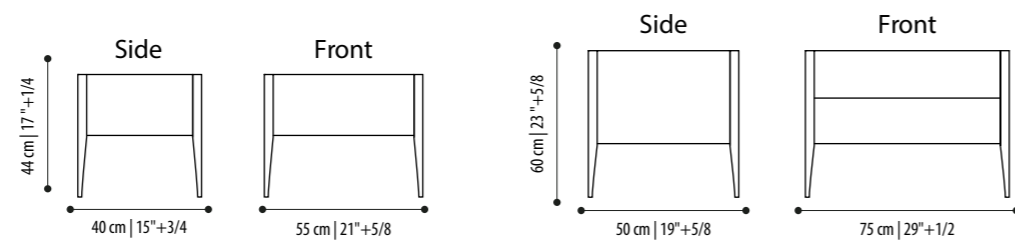

HUGS

design Joe Garzone



Struttura

In legno impiallacciato in diverse essenze o legno laccato lucido o opaco

Cassetti

Interno in legno impiallacciato, effetto pelle

Piedi

In legno massello in diverse essenze con tacco in ottone

Structure

In wood veneered in different essences or glossy or matt lacquered wood

Drawers

Interior in veneered wood, leather effect

Top

In solid wood in different essences with brass heel

Settimino / Chest of 7 drawers

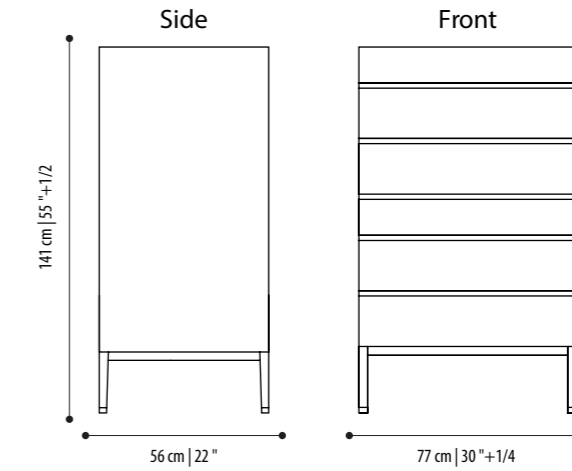

Comò / Chest of drawers

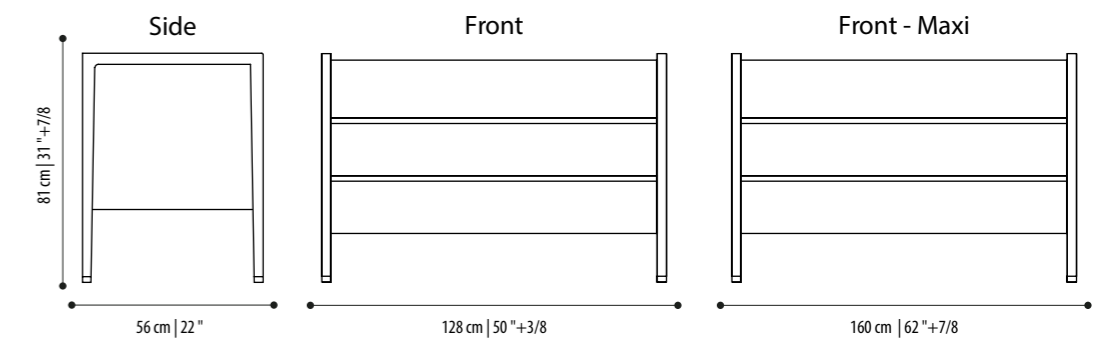

Comodino / Bedside table

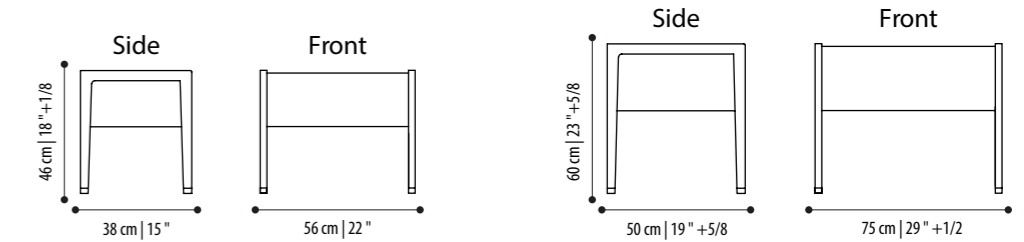

AVENUE

design Joe Garzone



Struttura

In legno impiallacciato in diverse essenze o legno laccato lucido o opaco

Cassetti

Interno in legno impiallacciato, effetto pelle

Piedi

In metallo pressofuso, verniciato in diverse finiture

Structure

In wood veneered in different essences or glossy or matt lacquered wood

Drawers

Interior in veneered wood, leather effect

Top

In die-cast metal, painted in different finishes

Settimino / Chest of 7 drawers

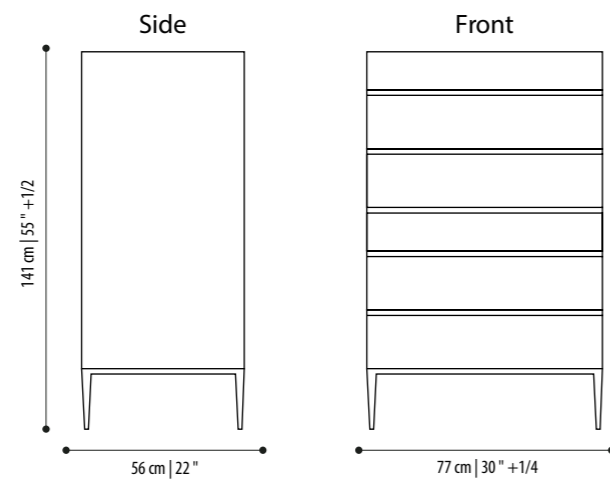

Comò / Chest of drawers

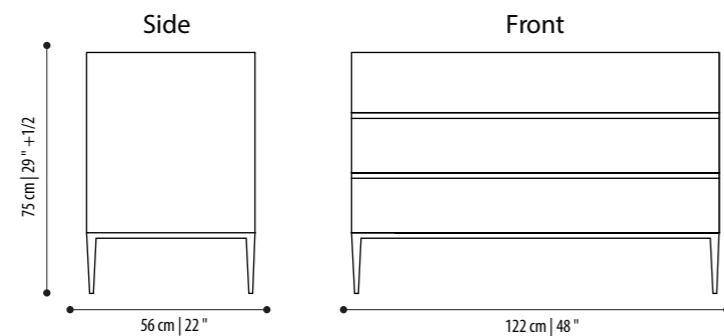

Comodino / Bedside table

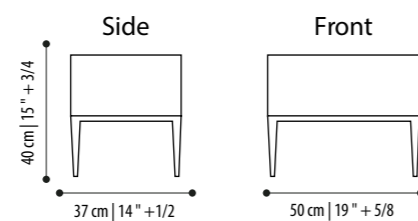

MOSCOVA

design Joe Garzone



Struttura esterna dei cassetti

In legno impiallacciato in diverse essenze

Cassetti

In legno laccato lucido o opaco, in diverse colorazioni

Piano

In pelle Nabuk o Eco-Nabuk lavabile

Structure

In wood veneered in different essences

Drawers

In glossy or matt lacquered wood, in different colours

Top

In Nabuk leather or washable Eco-Nabuk leather

Comò / Chest of drawers

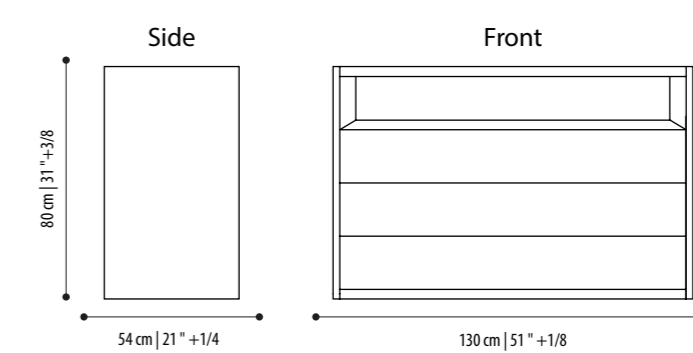

Comodino / Bedside table

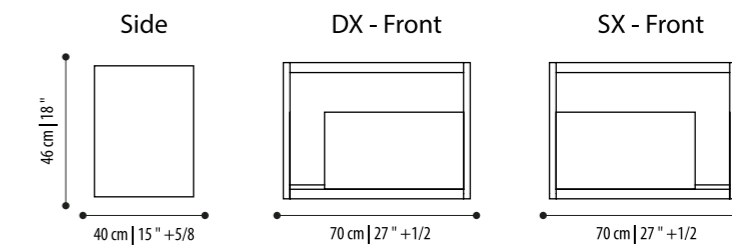

FONTANA

design Joe Garzone



Scrivania / Writing desk

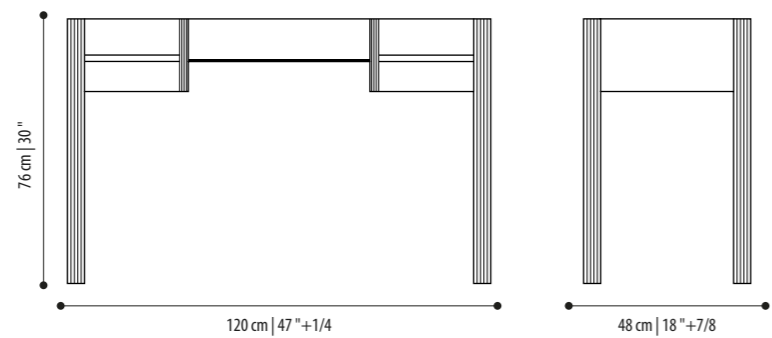

Struttura

In legno impiallacciato o massello, in diverse essenze

Cassetti

Interno cassetti impiallacciato effetto pelle

Piano

In pelle Nabuk

Structure

In veneered or solid wood, in different essences

Drawers

Internal drawers in leather effect veneer

Top

In Nabuk leather

IRON

design Joe Garzone



Scrivania / Writing desk

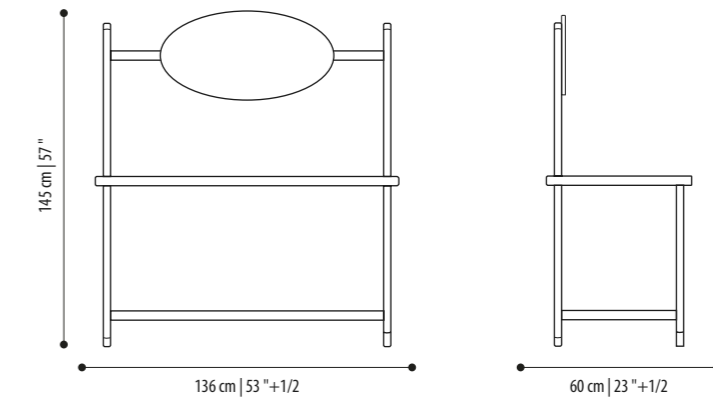

Struttura

In metallo verniciato con dettagli in ottone
Brunito e legno multistrato

Piano

in pelle Nabuk o Eco-Nabuk lavabile

Structure

In painted metal with details in bronzed brass and plywood

Top

In washable Nabuk or Eco-Nabuk leather

IRON

design Joe Garzone



Panca / Bench

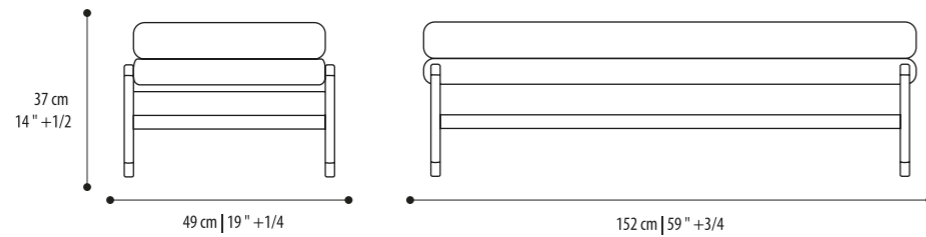

Struttura

In metallo verniciato con dettagli in ottone
Brunito e legno multistrato

Imbottitura

In poliuretano espanso ad alta densità

Rivestimento

In tessuto o pelle, non sfoderabile

Structure

In painted metal with details in bronzed brass and plywood

Padding

In high density polyurethane foam

Upholstery

In fabric or leather, non-removable

DOMINICK

design Joe Garzone



Panca / Bench

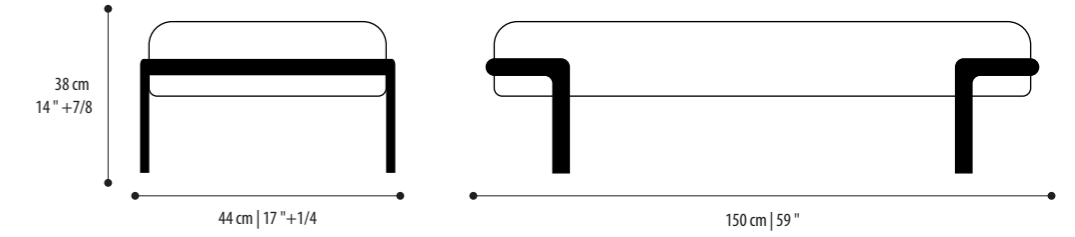

Struttura

In legno massello curvato in diverse finiture

Imbottitura

In poliuretano espanso e Memory Foam ad alta densità

Rivestimento

In tessuto o pelle, non sfoderabile

Structure

In curved solid wood in different finishes

Padding

In polyurethane foam and high density Memory Foam

Upholstery

In fabric or leather, non-removable

MARIE

design Joe Garzone



Panca / Bench

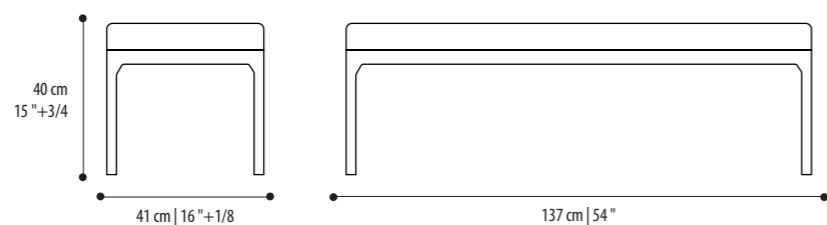

Struttura

In legno massello, noce canaletto o frassino verniciato in diverse colorazioni

Imbottitura

In poliuretano espanso ad alta densità

Rivestimento

In tessuto o pelle, non sfoderabile

Structure

In solid wood, Canaletto walnut or painted ash in different colors

Padding

In high density polyurethane foam

Upholstery

In fabric or leather, non-removable

AVENUE

design Joe Garzone



Panca / Bench

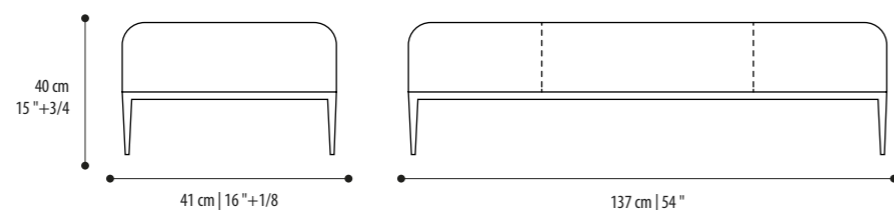

Struttura

In metallo pressofuso verniciato bronzo o black

Imbottitura

poliuretano espanso ad alta densità

Rivestimento

In tessuto o pelle, non sfoderabile

Structure

In bronze or black painted die-cast metal

Padding

In high density polyurethane foam

Upholstery

In fabric or leather, non-removable

LOUIS

design Joe Garzone



Panca / Bench

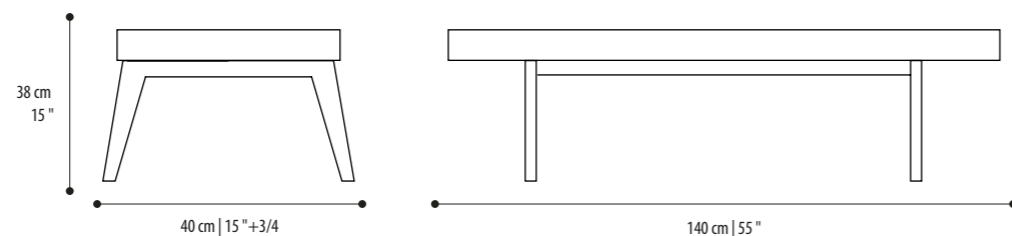

Struttura

In legno impiallacciato in diverse finiture

Piedi

In noce Canaletto o frassino verniciato

Structure

In wood veneered in different finishes

Foot

In Canaletto walnut or painted ash

CORBUSIER

design Joe Garzone



Panca / Bench

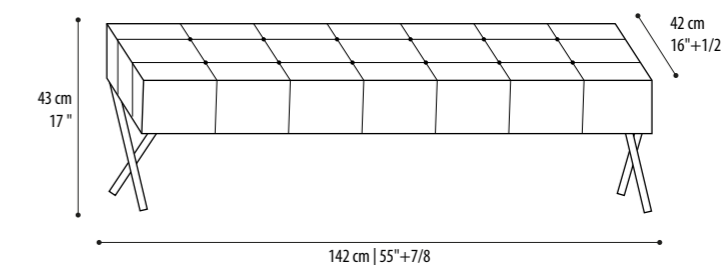

Struttura

In legno multistrato e piedi in metallo verniciato

Imbottitura

In poliuretano espanso ad alta densità

Rivestimento

In tessuto o pelle, non sfoderabile

Structure

In plywood and painted metal feet

Padding

In high density polyurethane foam

Upholstery

In fabric or leather, non-removable

CHARLIE

design Joe Garzone



Panca / Bench

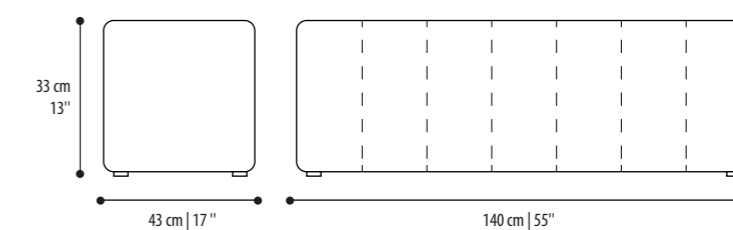

Struttura

In legno multistrato e piedi in acciaio verniciato

Imbottitura

In poliuretano espanso ad alta densità

Rivestimento

In tessuto o pelle, non sfoderabile

Structure

In plywood and painted metal feet

Padding

In high density polyurethane foam

Upholstery

In fabric or leather, non-removable

INTRECCIO

design Joe Garzone



Panca / Bench

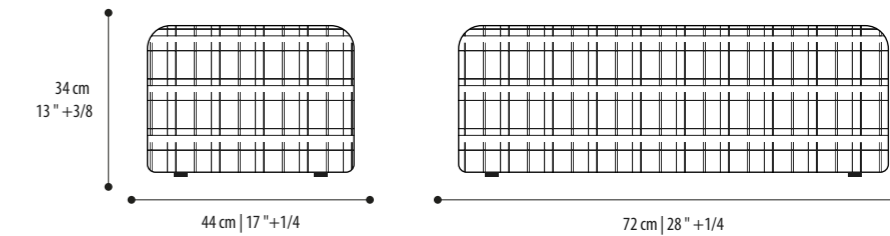

Struttura

legno multistrato e piedi in acciaio verniciato

Imbottitura

In poliuretano espanso ad alta densità

Rivestimento

In pelle intrecciata, non sfoderabile

Structure

In plywood and painted metal feet

Padding

In high density polyurethane foam

Upholstery

In fabric or leather, non-removable

CHARLIE

design Joe Garzone



Poltrona / Armchair

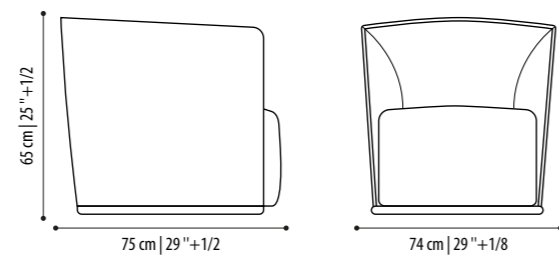

Struttura

In legno multistrato e base in diverse finiture metalliche

Imbottitura

In poliuretano espanso ad alta densità

Rivestimento

In tessuto o pelle non sfoderabile

Structure

In plywood and base in different metal finishes

Padding

In high density polyurethane foam

Upholstery

In fabric or leather, non-removable

HUGS

design Joe Garzone



Poltrona / Armchair

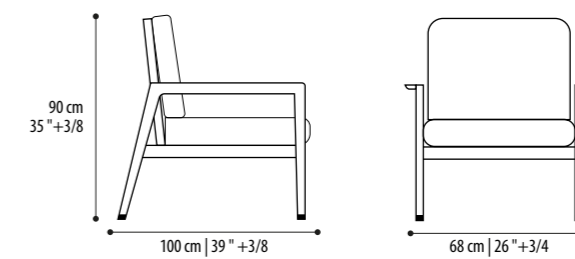

Struttura

In legno massello o frassino verniciato marrone, nero, grigio o avorio con dettagli in ottone

Imbottitura

In poliuretano espanso ad alta densità

Rivestimento

In tessuto o pelle sfoderabile

Structure

In solid wood Canaletto walnut or brown, black or grey painted ash with brass details

Padding

In high density polyurethane foam

Upholstery

In fabric or leather, removable

CHELSEA

design Conte Studio



Poltrona / Armchair

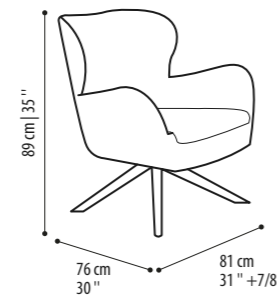

Struttura

In ferro e poliuretano espanso schiumato piedi in legno verniciato

Rivestimento

in tessuto o pelle non sfoderabile

Structure

In iron and polyurethane foam, wood painted feet

Upholstery

In fabric or leather, non-removable

QUEEN + POUF

design Conte Studio



Poltrona e Pouf / Armchair and Pouf

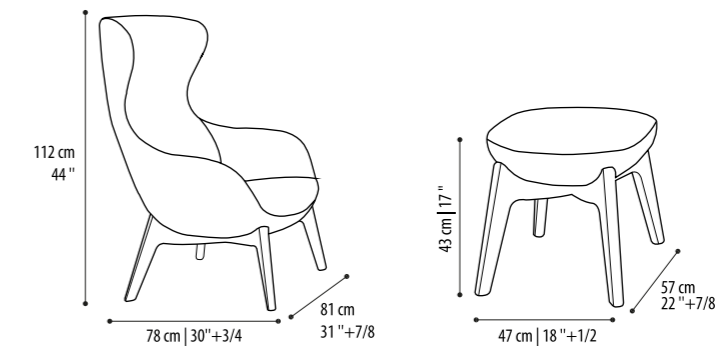

Struttura

In ferro e poliuretano espanso schiumato piedi in legno verniciato

Rivestimento

in tessuto o pelle non sfoderabile

Structure

In iron and polyurethane foam painted wood feet

Upholstery

In fabric or leather, non-removable

KARL

design Joe Garzone

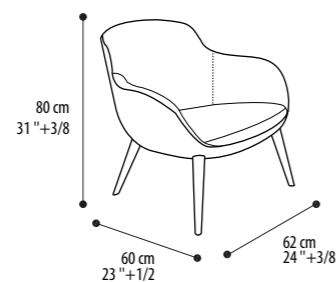

Struttura

In ferro e poliuretano espanso schiumato piedi in legno verniciato

Rivestimento

In tessuto o pelle non sfoderabile

Structure

In iron and polyurethane foam, wood painted foot

Upholstery

In fabric or leather, non-removable

Poltrona / Armchair

DOMINICK

design Enrico Cesana

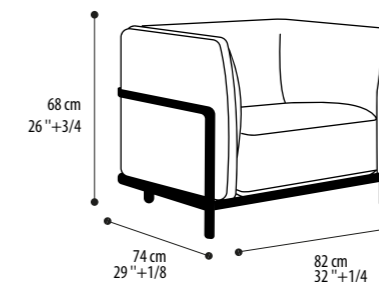

Struttura

In legno massello, Noce Canaletto o frassino verniciato marrone, nero, grigio o avorio

Imbottitura

In poliuretano espanso ad alta densità

Rivestimento

In tessuto o pelle sfoderabile

Structure

In solid wood, Canaletto walnut or brown, black or grey painted ash

Padding

In high density polyurethane foam

Upholstery

In removable fabric or leather

Poltrona / Armchair

ANNETTE

design Conte Studio

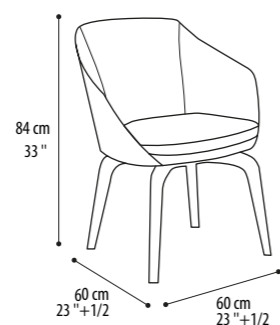

Struttura

In ferro e poliuretano espanso schiumato piedi in legno verniciato

Rivestimento

In tessuto o pelle non sfoderabile

Structure

In iron and polyurethane foam, wood painted foot

Upholstery

In fabric or leather, non-removable

Poltrona / Armchair

PARIS

design Conte Studio

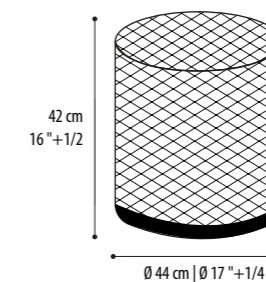

Struttura

In legno multistrato e base in metallo verniciato o ottone

Imbottitura

In poliuretano espanso ad alta densità

Rivestimento

In tessuto o pelle non sfoderabile

Structure

In plywood and base in painted metal or brass

Padding

In high density polyurethane foam

Upholstery

In fabric or leather, non-removable

Pouf

LOUIS

design Joe Garzone



Tavolino / Side Table

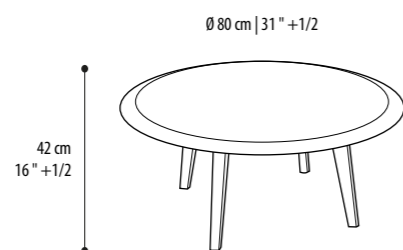

Struttura
In legno massello lucido o opaco
Piedi
In frassino verniciato in diverse colorazioni

Structure
In glossy or matt solid wood
Feet
In painted ash in different colours

BERGÈRE

design Enrico Cesana



Tavolino / Side Table

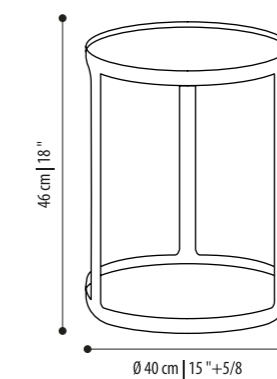

Struttura
In legno massello laccato opaco in diverse colorazioni
Piano
In marmo o vetro in diverse finiture

Structure
In matt lacquered solid wood in different colours
Top
In marble or glass with different finishes

CHARLIE

design Joe Garzone



Tavolino / Side Table

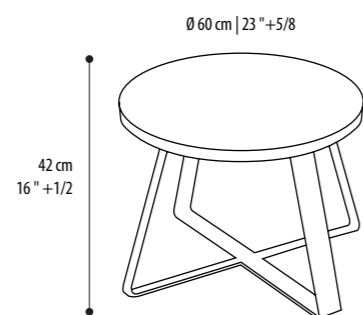

Struttura
In metallo verniciato in diverse finiture
Piano
In marmo o vetro in diverse finiture

Structure
In painted metal in different finishes
Top
In marble or glass with different finishes

VERSAILLES

design Joe Garzone



Tavolino / Side Table

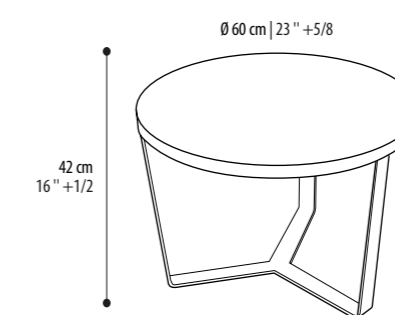

Struttura
In metallo verniciato in diverse finiture
Piano
In marmo o vetro in diverse finiture

Structure
In painted metal in different finishes
Top
In marble or glass with different finishes

IRON ALTO

design Kiril Stanev



Tavolino / Side Table

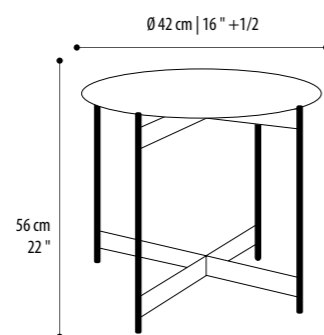

Struttura
In metallo verniciato in diverse finiture
Piano
In marmo in diverse finiture

Structure
In painted metal in different finishes
Top
In marble with different finishes

IRON BASSO

design Kiril Stanev



Tavolino / Side Table

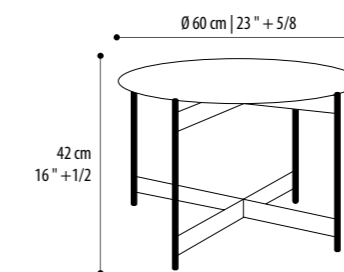

Struttura
In metallo verniciato in diverse finiture
Piano
In marmo in diverse finiture

Structure
In painted metal in different finishes
Top
In marble with different finishes

DOMINICK

design Enrico Cesana



Chaise Longue

VERS. SX

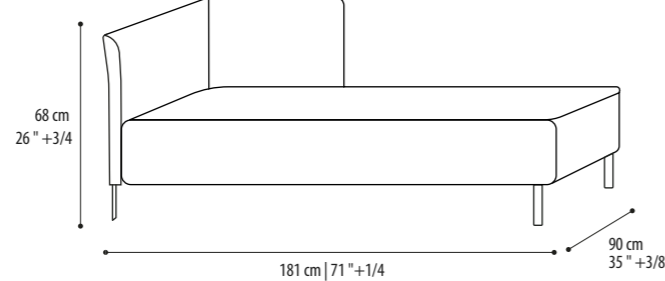

VERS. DX

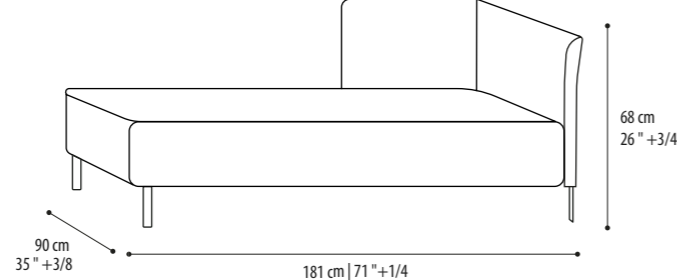

Struttura

In legno massello curvato in diverse essenze

Imbottitura

poliuretano espanso e Memory Foam

Rivestimento
in tessuto o pelle non sfoderabile

Structure

In curved solid wood in different essences

Padding

In polyurethane foam and Memory Foam

Upholstery
In fabric or leather, non-removable

MOSCOVA ALTA

design Conte Studio



Chaise Longue

VERS. SX

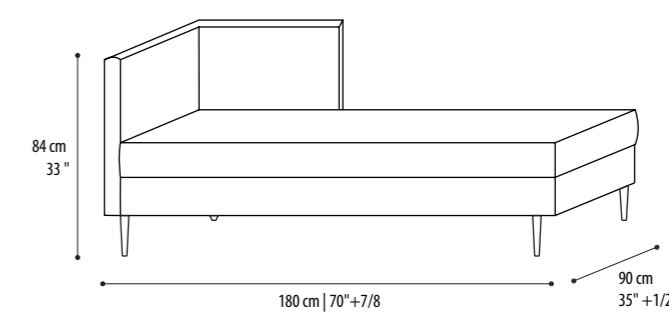

VERS. DX

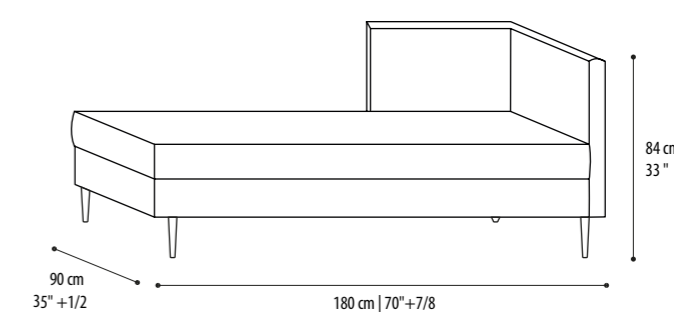

Struttura

In legno multistrato e piedi in metallo verniciato

Imbottitura

In poliuretano espanso ad alta densità

Rivestimento
in tessuto o pelle non sfoderabile

Structure

in plywood and painted metal feet

Padding

In high density polyurethane foam

Upholstery
In fabric or leather, non-removable

MOSCOVA BASSA

design Conte Studio



Chaise Longue

VERS. SX

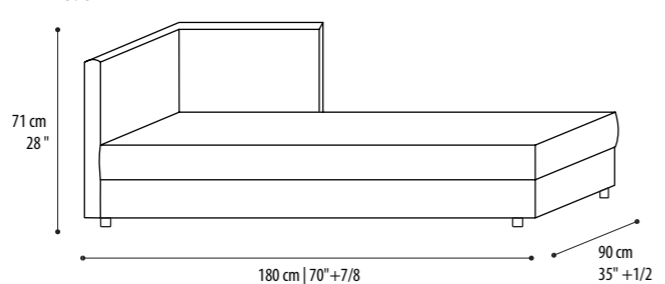

VERS. DX

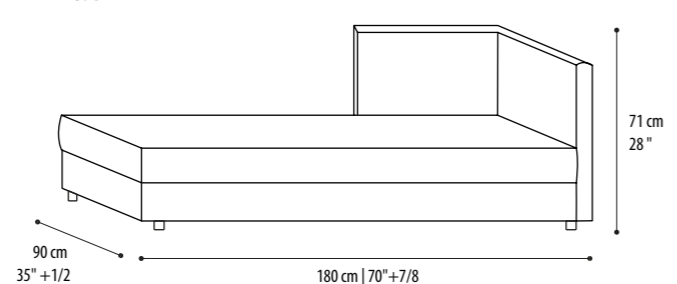

Struttura

In legno multistrato e piedi in metallo verniciato

Imbottitura

In poliuretano espanso ad alta densità

Rivestimento
in tessuto o pelle non sfoderabile

Structure

in plywood and painted metal feet

Padding

In high density polyurethane foam

Upholstery
In fabric or leather, non-removable

KARL MAXI / KARL

design Joe Garzone



Specchio / Mirror

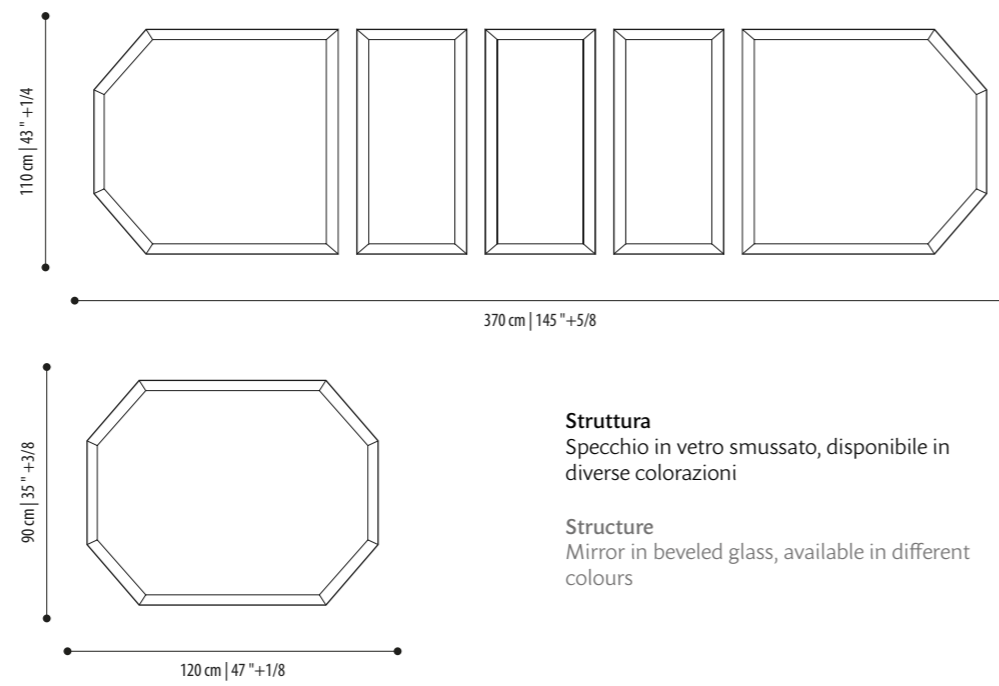

Struttura
Specchio in vetro smussato, disponibile in diverse colorazioni

Structure
Mirror in beveled glass, available in different colours

VERSAILLES

design Joe Garzone



Specchio / Mirror

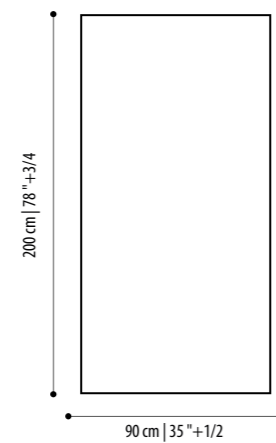

Struttura
In metallo verniciato in diverse finiture

Structure
In painted metal in different finishes

VERSAILLES MAXI

design Joe Garzone



Specchio / Mirror

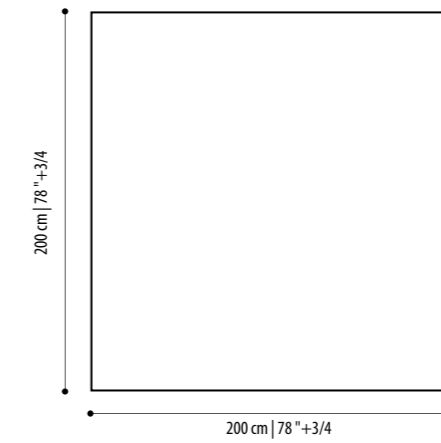

Struttura
In metallo verniciato in diverse finiture

Structure
In painted metal in different finishes

CIRCO

design Joe Garzone



Specchio / Mirror

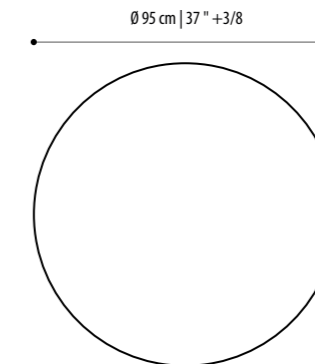

Struttura
In metallo verniciato in diverse finiture o ottone Brunito

Structure
In painted metal in different finishes or bronzed brass

MATERIALI
MATERIALS

MARMO | MARBLE



IMPIALLACCIATI | VENEERED

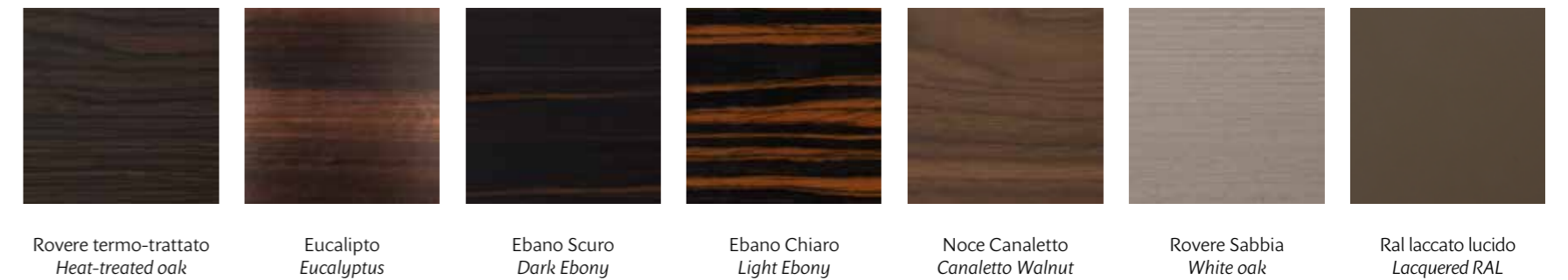

METALLI | METALS

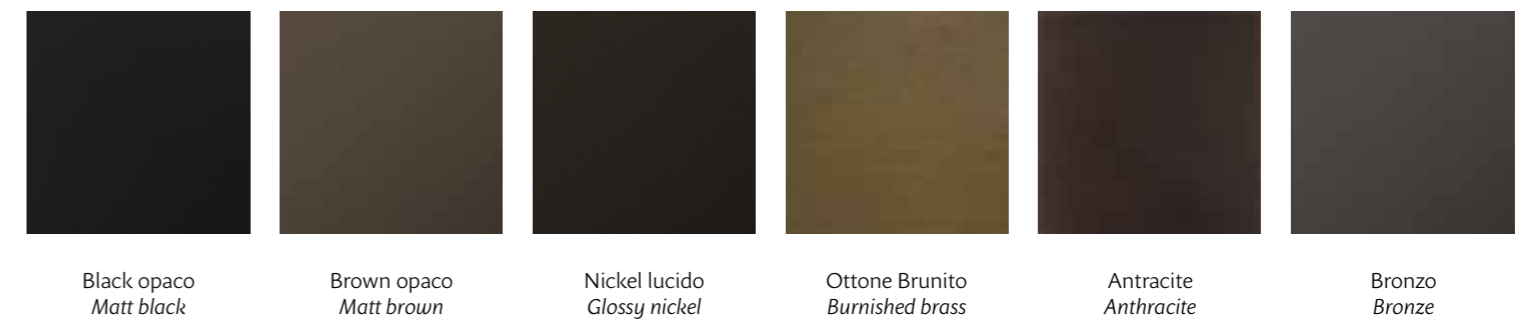

MASSELLI | SOLID WOOD



VETRI | GLASS

CONDIZIONI GENERALI DI VENDITA

ORDINI

L'ordinazione implica l'integrale accettazione delle presenti nostre condizioni di vendita, alle quali NON è ammessa deroga alcuna, se non espressamente convenuta per iscritto. Essa si ritiene irrevocabile trascorse ventiquattro ore dal momento in cui CONTE GROUP s.r.l. ne comunica la conferma; pertanto, le parti espressamente convengono che, decorso tal termine, la committente sarà comunque tenuta ad accettare la consegna e ad effettuare l'integrale pagamento, secondo i termini, le modalità e le condizioni previste nel documento di conferma. Le ordinazioni passate ad intermediari, ad agenti di vendita o direttamente in azienda, vengono da CONTE GROUP s.r.l. assunte con la clausola specifica “salvo approvazione della società venditrice”. Eventuali richieste di formati o prodotti particolari saranno valutate di volta in volta.

CONFERMA D'ORDINE E CONSEGNA
CONTE GROUP s.r.l. invierà ciascuna conferma d'ordine indicando i termini approssimativi di consegna al Cliente, decorrenti dalla data della conferma, annotando la concordata modalità di pagamento ed eventuali altre condizioni. La merce viaggia a rischio del committente anche se venduta in porto franco. Spettano pertanto al destinatario la cura e la responsabilità di verificare lo stato del materiale al momento della consegna e di inoltrare contestualmente eventuali reclami al vettore. I termini di consegna non sono in alcun caso tassativi, ma puramente indicativi. Eventuali ritardi non possono quindi costituire motivo di rinuncia o di modifica degli accordi specificati sulla commissione o in nessun caso rivalsa nei confronti del produttore.

TRASPORTO
Condizioni e termini di trasporto saranno definiti di volta in volta con la conferma d'ordine inviata dalla CONTE GROUP s.r.l..

PRODOTTI
I prodotti sono quelli pubblicati e specificati per tipologia nel vigente catalogo. In funzione dell'aggiornamento tecnologico o al fine di migliorare il prodotto, CONTE GROUP s.r.l. può apportare qualsiasi modifica ai suoi prodotti, senza l'obbligo di notificarle alla committente. Le dimensioni dei prodotti sono espresse in centimetri; la produzione è di tipo manifatturiero e può determinare una piccola tolleranza nelle dimensioni indicate, in larghezza, in altezza e in lunghezza. Ove sia necessario per la realizzazione di un manufatto avere delle incollature, le stesse saranno effettuate preservandone il confort. La gamma dei materassi e guanciali prodotti è costituita in gran parte da poliuretani ecologici e viscoelastici; può nel tempo avere una naturale ossidazione (leggero cambio di colore) ma tal eventualità non altera le proprietà del prodotto.

FUORI MISURA E TEMPI DI CONSEGNA
Le richieste di articoli con misure e finiture non di serie saranno valutate di volta in volta da CONTE GROUP s.r.l.; ove sia ritenuto possibile soddisfare tali richieste, saranno comunicati il costo aggiuntivo ed i tempi approssimativi di consegna.

LISTINO
I prezzi indicati sul listino vigente non sono comprensivi di IVA e rappresentano i prezzi suggeriti da CONTE GROUP s.r.l. ai propri rivenditori.

GARANZIA – RECLAMI – RESI
CONTE GROUP s.r.l. garantisce i suoi manufatti a norma della di Direttiva Europea 1999 / 44 / CE attuata in Italia con il Decreto Legislativo n° 24 / 2002 cui si rinvia ai fini della garanzia di due anni, ove il prodotto sia descritto fiscalmente come ceduto a privato. La garanzia tutela eventuali difetti occulti del prodotto, con esclusione di difetti causati da un uso improprio (urti, strappi, lavaggi sbagliati, muffe e macchie di qualsiasi genere e tipo) e o da una cattiva gestione della manutenzione. Per le specifiche previsioni contrattuali in ordine a garanzia del produttore, reclami e resi si rinvia espressamente a quanto previsto nel “Certificato di Garanzia”, consegnato contestualmente all’acquisto. In caso di non conformità di ogni genere, il reclamo deve essere inoltrato per iscritto entro e non oltre 5 giorni dal ricevimento. La merce riconosciuta difettosa sarà sostituita con altra uguale o con le medesime caratteristiche. La responsabilità della CONTE GROUP s.r.l., in relazione ai prodotti difettosi non si estende in nessun caso oltre la sostituzione della merce difettosa; non saranno quindi accettate richieste di danni o penali di ogni sorta. I resi per qualsivoglia motivo devono essere autorizzati dalla CONTE GROUP s.r.l.; il reso implica necessariamente un idoneo imballo e una definizione di causale con accettazione da parte dell’azienda. Non si accetta merce di ritorno senza preventiva autorizzazione della CONTE GROUP s.r.l..

PAGAMENTI
Le modalità di pagamento sono concordate in sede d’ordine, in forma scritta. Ogni spedizione è da considerare indipendente dalle altre agli effetti del pagamento. Il ritardo nei pagamenti da parte del committente autorizza CONTE GROUP s.r.l. alla sospensione di ogni ulteriore fornitura. Qualunque contestazione sorgesse tra le parti, anche relativa

alle garanzie consentite ed accettate, non comporterà alcun prolungamento nei termini di pagamento convenuti, né il diritto di sospenderli o modificarli, e qualsiasi azione del Cliente non potrà essere ritenuta procedibile se lo stesso non proverà di essere in regola con i pagamenti.

RITARDO NEI PAGAMENTI
In caso di ritardo nel pagamento, si applicherà l’interesse commerciale di mora, come per legge. In caso di controversia, l’acquirente non ha alcun diritto di ritardare o rifiutare il pagamento delle forniture in scadenza. Le vendite con pagamento differito si intendono eseguite con riserva di proprietà da parte del produttore fino all’avvenuto saldo.

CONTO LAVORO
CONTE GROUP s.r.l. accetta commissioni di “conto lavoro” solo su tessuti in tinta unita e comunque non su articoli in pelle. CONTE GROUP s.r.l. si riserva, in ogni caso, la facoltà di valutare eccezionali richieste e di formulare preventivi relativi ai tempi di consegna ed ai costi.

STRUTTURA
Le strutture dei letti sono realizzate in multistrato o in truciolare di legno. Le imbottiture, in poliuretano espanso ad alta densità, sono rivestite in tessuto aggrappante. Qualora il modello lo preveda, la sfoderabilità del letto è garantita sia nelle versioni in tessuto che in quella in pelle.

PELLI E TESSUTI
Le pelli con cui vengono realizzati i prodotti di CONTE GROUP s.r.l. provengono dai migliori allevamenti bovini. Le pelli selezionate vengono trattate in concerta con delle moderne tecniche di colorazione e lavorazione. I segni, come rughe e cicatrici, manifestano il valore delle pelli naturali; ogni letto o complemento in pelle ha particolarità proprie in quanto ogni manto utilizzato per la sua realizzazione ha una storia diversa degli altri che è possibile percepire attraverso i segni naturali impressi in superficie (cicatrici, venature, ombre, graffi, riflessi di tonalità e rughe naturali) che il conciatore mantiene volutamente intatte per salvaguardare la naturalezza dell’articolo. Vi consigliamo di non esporre gli articoli realizzati in pelle vicino a fonti di calore e di evitare l’esposizione diretta alla luce del sole; questo, per prevenire la perdita di colore originaria del rivestimento. Il campionario tessile è disponibile con oltre 300 tessuti che comprendono svariate tonalità di colore, tessuti antimacchia e lavabili, ecopelli, velluti e lini.

BIANCHERIA
La nostra biancheria è resa esclusiva dall’accurata confezione e dalle vaste possibilità di personalizzazione degli articoli. Sono disponibili più di 500 varianti di colore, abbinabili fra loro. I tessuti utilizzati sono: lino, raso, cotone e velluto. Il campionario tessile comprende anche: cuscini, rulli, plaid, piumini e copripiumini.

USO DEL MARCHIO E DEGLI ELEMENTI DISTINTIVI
L’uso del marchio, del logo e del nome a dominio concesso sulla base di eventuali specifici accordi contrattuali in forma scritta, è da intendersi strettamente limitato a quanto in essi stabilito. Eventuali abusi consistenti in utilizzi impropri e comunque contrari al principio di correttezza e buona fede, costituiscono violazione delle norme civilistiche e di quelle speciali in materia di proprietà industriale (D.lgs. n. 30 del 2005 “Codice della Proprietà Industriale”) e, come tali, sono perseguibili e sanzionabili. La titolarità esclusiva dei diritti di sfruttamento economico derivanti dai suoi prodotti spetta unicamente al titolare del marchio e, pertanto, è vietata la vendita attraverso canali -anche pubblicitari- non specificamente autorizzati.

PRIVACY
I dati personali richiesti in fase di inoltro dell’ordine sono raccolti e trattati al fine di soddisfare le espresse richieste della committente e non verranno in nessun caso e a nessun titolo ceduti a terzi. CONTE GROUP s.r.l. srl garantisce ai propri clienti il rispetto della normativa in materia di trattamento dei dati personali, disciplinata dal codice della privacy di cui al DL 196 del 30.06.03 e successive modifiche ed integrazioni. Titolare del trattamento dati è CONTE GROUP s.r.l. srl. Il cliente può chiedere, come previsto dalla citata legge, la conferma dell’esistenza dei dati, la loro visione, integrazione, aggiornamento e cancellazione.

FORO COMPETENTE
La risoluzione di ogni controversia relativa al presente contratto è devoluta, convenzionalmente ed esclusivamente, all’Autorità Giudiziaria territorialmente competente per Altamura (BA).

ORDERS

The order implies the full acceptance of these our conditions of sale, to which NO derogation can be allowed, unless expressly agreed in writing. It is irrevocable passed twenty-four hours from the moment CONTE GROUP s.r.l. shall communicate the confirmation; therefore, the parties expressly agree that, upon expiry of this period, the purchaser will still be obliged to accept the delivery and to make the full payment, according to the terms, the terms and conditions provided for the confirmation document. Orders passed to intermediaries, sales agents or directly in the farm, come from CONTE GROUP s.r.l. taken with the specific clause “unless approved by the seller.” Any requests for sizes or particular products will be evaluated from time to time.

ORDER CONFIRMATION AND DELIVERY
CONTE GROUP s.r.l. s.r.l. will send each order confirmation indicating the approximate delivery time to the Customer, from the date of confirmation, noting the agreed terms of payment and any other conditions. The goods travel at risk of the purchaser even if sold free port. Therefore it is entitled to the recipient the care and the responsibility to verify the status of the material at the time of delivery and to forward any complaints to the carrier simultaneously. Delivery dates are not in any event mandatory, but merely indicative. Any delays can’t therefore constitute reason for waiver or modification of the specified agreements on commission or in any event recourse against the manufacturer.

TRANSPORT
Condition and transport terms will be defined time by time with the order confirmation of Conte Group s.r.l..

PRODUCTS
The products are those published and specified by type in the current catalog. On the basis of technological updating or in order to improve the product, CONTE GROUP s.r.l. s.r.l. may make any change to its products, without obligation to notify them to the purchaser. The dimensions of the products are expressed in centimeters; the production is of the manufacturing type and can determine a small tolerance in the indicated dimensions, in width, in height and in length. Where it is necessary for the realization of a manufactured product having gluing, the same will be carried out preserving the comfort. The mattresses and pillows range consists mainly of ecological and viscoelastic polyurethanes; it may have over time a natural oxidation (light color change), but this possibility does not alter the product properties.

NON STANDARD SIZES AND TIMES OF DELIVERY
Requests for products with non-standard sizes and finishes will be evaluated from time to time by CONTE GROUP s.r.l.; where it is possible to satisfy these requirements, the additional cost and the approximate times of delivery will be communicated.

PRICE LIST
The prices indicated on the current price list do not include VAT and represent the suggested prices from CONTE GROUP s.r.l. to its dealers.

GUARANTEE - COMPLAINTS - RETURNS
CONTE GROUP s.r.l. guarantees its products according to the European Directive 1999/44 / CE carried out in Italy by Legislative Decree No. 24/2002 which refers to a guarantee of two years, if the product is described fiscally as sold to private. The guarantee protects any hidden defects of the product, with the exception of defects caused by improper use (knocks, cuts, wrong washes, mould and stains of any kind and type) and/or by a poor maintenance management. For specific contractual provisions in order to manufacturer’s guarantee, complaints and returns it expressly refers to the provisions in the “Guarantee Certificate”, delivered at the time of purchase.

In case of non-compliance of any kind, the complaint must be forwarded in writing no later than 5 days after receipt. The recognized defective goods will be replaced with the same or with the same characteristics. The responsibility of CONTE GROUP s.r.l., in relation to defective products, does not extend in any case more than the replacement of the defective goods; will not be accepted requests for damages or penalties of any sort. Returns for any reason must be authorized by CONTE GROUP s.r.l.; the return necessarily implies a suitable packaging and a definition of causal with acceptance by the company. We do not accept return merchandise without prior authorization by CONTE GROUP s.r.l..

PAYMENTS
The payment methods are agreed at the time of order, in written form. Each consignment is to be considered independent of the others to the effects of the payment. The delay in payment by the purchaser authorizes CONTE GROUP s.r.l. to suspension of any other delivery. Any dispute arise between the parties, also relating to the permitted and accepted guarantees, will not lead any extension of the agreed payment terms, nor the right to suspend or modify them, and any action of the Client can’t be considered prosecutable if the same will not try to be up to date with payments.

GENERAL CONDITIONS OF SALE

DELAY IN PAYMENT

In case of delay in payment, it will apply the commercial interest for late payment, as required by law. In case of a dispute, the buyer has no right to delay or refuse payment of supplies due. Sales with deferred payment are made with reservation of ownership by the manufacturer until payment obtained.

WORK ACCOUNT
CONTE GROUP s.r.l. accepts commissions “work account” only on solid color fabrics and in any case not on leather goods. CONTE GROUP s.r.l. reserves, in any case, the right to consider exceptional requests and formulate estimates relating to delivery times and costs.

STRUCTURE
The structure of the beds are made of plywood or chipboard. The padding in high density polyurethane, are coated in an adhesion fabric. If the model provides, the removable cover of the bed is guaranteed both in the fabric version than in the leather.

LEATHERS AND FABRICS
The leathers with which the CONTE GROUP s.r.l. products are made come from the best cattle farming. The selected leathers are treated in tannery with modern techniques of color and processing. The signs such as wrinkles and scars, show the value of natural leathers; each bed or leather complement has particular features as each mantle used for its realization has a different story of the others that it is possible to perceive by the natural signs impressed on the surface (scars, veins, shadows, scratches, reflections and shades of natural wrinkles) that the tanner deliberately keeps intact to preserve the naturalness of the article. We advise you not to expose the articles made of leather near heat sources and avoid direct exposure to sunlight; this, to prevent the loss of the original color of the Covering. The textile samples is available with over 300 fabrics that include various shades of color, stain-resistant and washable fabrics, eco-leather, velvets and linens.

BED LINEN
Our linen is exclusively made of the accurate packaging and the wide possibilities of personalization of the articles. More than 500 variants of color, are available, matched between them. The fabrics used are: linen, satin, cotton and velvet. The textile samples also includes: pillows, rolls, plaid, duvets and duvet covers.

USE OF TRADEMARK AND DISTINCTIVE ELEMENTS
The use of the trademark, logo and the domain name given on the basis of any specific contractual agreements in writing, it is to be understood strictly limited to what is established in them. Any substantial misuse and abuse in any case contrary to the principle of fairness and good faith, represents a violation of civil law and special ones in the field of industrial property (Legislative Decree. No. 30 of 2005 “Code of Industrial Property”) and, as such, they are prosecuted and sanctioned. The exclusive ownership of the economic exploitation rights from its products is only up to the owner of the mark and, therefore, the sale is prohibited through channels- also advertising- not specifically authorized.

PRIVACY
The personal data requested during the placing order are collected and processed to meet the expressed demands of the purchaser and will not in any case and for any reason sold to third parties. CONTE GROUP s.r.l. srl guarantees its customers the compliance with rules on the processing of personal data covered by the Privacy Code of LD 196, 30.06.03. The holder of the data treatment is CONTE GROUP s.r.l. srl. The customer may request, as required by the mentioned law, the confirmation of the existence of data, their vision, integration, updating and deletion.

JURISDICTION
The resolution of any dispute relating to this contract shall be referred, conventionally and exclusively, to the competent Judicial Authority within Altamura (BA).

Handmade in Italy. **Everything.**

Conte[®]
ITALIAN BED DESIGN

www.contebed.it